



2023 / 2024

## Original Equipment for the aftermarket

Spiegelsysteme für Nutzfahrzeuge  
Mirror systems for commercial vehicles





## Inhalt index

### **Aufbau der MEKRA Artikelnummern**

---

Structure of the MEKRA article numbers 04

### **Verzeichnis der Spiegel-Typen**

---

Mirror type list 05

### **Liste aller MEKRA Artikel im Katalog**

---

List of all MEKRA-articles in this catalogue 06-07

### **Homologationsnummernliste**

---

List of homologation numbers 08-09

### **Vergleichsliste nach OE - Nummern**

---

Cross-reference-table 10-17

### **Fahrzeughersteller**

---

Manufacturer 18-79

DAF 18-22

FORD 23

IVECO 24-25

MAN 26-41

MERCEDES 42-55

RENAULT 56-58

SCANIA 59

VOLVO 60-63

VOLKSWAGEN (VW) 63-65

UNIVERSAL 66-79

### **Allgemeine Verkaufs- und Lieferbedingungen**

---

General terms and conditions of sale and delivery 80-81

## 9 stellig digit

04...	
08...	
09...	
10...	
11...	
13...	
14...	
15...	
20...	
39...	
40...	
51...	
53...	
55...	
56...	
58...	
59...	
61...	 

3. - 5. Ziffer digit = Spiegeltyp mirror type

## 12 stellig digit

08...	
09...	
11...	
12...	
14...	
15...	
19...	
20...	
40...	
51...	
55...	
56...	
58...	
59...	 
61...	 

3. - 6. Ziffer digit = Spiegeltyp mirror type

z. B. / e. g. 59.5800.101H = Typ / type 580

59.2910.001.001 = Typ / type 291

59.1018.003.099 = Typ / type 1018



152 ASKB	68
224	62
248/2 A	77
249 K	51
249 L	51
250	60
251	28
252	60
253	42
254	42
260	26
265	27
266	27
266-1	27
270 A	79
271	38,73
271 A	77
276	38
277	40
278	39
279	25
281	50
289	68
291	74,75
300	67
320	26
340	26
341	26
348	19,19,58,58
349	51,63
349 TW	51,63
360	60
360-1	60
363	68
364	28
365-1	27
370	60
371	60
373	18,30
375	43
375 A	43
377	43,46



377-1	43,46
378	46
378 A	46
378-1	46
380-1	31
381-1	31
385	66
386	18,30
386-1	18
389	67
390	56,57,61
392	32
392-1	33
392-2	34
393	32
393-1	33
393-2	34
395	50
396	45,47
398	50
400	59
552	21
552-1	21,57,61,66,67
558	58,59,61
559	20,23
570	20
570 A	21
571	20
572	29,62
573	29,62
574	20
575	44
575 A	44
577	44
579	29,32,34,35,45,47
580	35
589	52,53,64,65
600	48
750	67
906	18,23
1000	63
1004	45,47,48



1005	21,23,59
1008	24,24,25
1009	69
1010	70
1012	48
1013	37,65
1016	78
1017	70
1017+1009	70
1018	72
1019	59
1020	37
1024	36
1025	21,58,62
1027	22
1036	71
1039	54,55
1041	41
1042	41
1043/1044	63



04.0603.007.000	32,33,34	11.3910.200H	22,56,61	15.3811.870H	31	19.5890.011.099	53,55,65	51.1009.049.099	69
08.1024.124.099	41,76	11.3921.110H	32,33	15.3861.114H	18	19.5890.012.099	53,55,65	51.1009.081.099	69
08.1039.001.099	54	11.3921.120H	32,33	15.3862.174H	18	19.5891.011.099	53,65	51.1009.097.099	69
08.1039.002.099	54	11.3921.400	33,34	15.3900.840H	56,57,61	19.5891.012.099	53,65	51.1009.113.099	69
08.1039.005.099	54	11.3931.110H	33	15.3910.871H	57	20.1016.004.000	78	51.1009.121.099	69
08.1039.006.099	54	11.3931.120H	33	15.3910.872H	57	20.1042.002.099	41	51.1009.122.099	69
08.1039.011.099	54	11.5700.100H	20	15.3911.871H	56,61	20.1042.003.099	41	51.1009.149.099	69
08.2770.001.000	40	11.5710.110H	20	15.3911.872H	56,61	20.2480.210H	77	51.1009.031.001	69
08.2910.001.002	40,75	11.5721.001.099	29,62	15.3920.840H	33	20.2480.211H	77	51.1009.242.099	69
08.3200.233H	39,40,72,75,76	11.5731.001.099	29,62	15.3921.870H	32	20.2480.213	73,77	51.1010.010.001	70
08.3950.001.099	40,75	11.5800.100H	35	15.3922.870H	32	20.2480.216H	38,50,73,77	51.1036.002.099	71
08.5380.004.000	62	11.5800.200H	35	15.3932.870H	33	20.2480.217H	38,50,73,77	51.1036.008.099	71
08.5752.012	39	11.9060.100H	18,23	15.3946.670F	27	20.2480.223	77	51.1036.009.099	71
08.5752.024.099	39,40,56	12.1005.001.099	23	15.3951.114	50	20.2700.200H	38,73	51.1036.010.099	71
	57,61,76	12.1018.001.099	72	15.3951.174	50	20.2710.111H	73	51.1036.021.099	71
08.5890.300.099	53,65	12.1018.002.099	72	15.3952.174	50	20.2710.121	73	51.1036.022.099	71
08.5890.301.099	53,65	12.1018.003.099	72	15.3961.174H	45,47	20.2710.200H	38,73	51.1036.023.099	71
08.5892.001.099	53,65	12.1018.005.099	72	15.4001.740H	59	20.2710.620	38,39,77	51.1036.024.099	71
08.5892.002.099	53,55,65	12.1018.007.099	72	15.4001.840H	59	20.2710.650	39	51.1036.025.099	71
08.5892.003.099	53,55,65	12.1018.009.001	72	15.5701.840H	20	20.3750.710.099	43	51.1036.026.099	71
08.5892.004.099	53,65	12.1018.010.001	72	15.5711.870H	20	20.3750.720.099	43	51.1043.001.099	63
08.5892.105.099	53,55,65	12.1020.003.099	37	15.5750.840H	44	20.3780.700H	46	51.1043.002.099	63
09.1000.200.099	63	12.1024.009.099	36	15.5770.870H	44	20.3900.510H	56,57,61	51.1044.001.099	63
09.1041.002.099	41	12.1024.010.099	36	15.5791.470H	29,32,45,47	20.3900.520H	56,57,61	51.1044.002.099	63
09.1041.004.099	41	12.1024.011.099	36	15.5791.570.099	29,32,34,35	20.5521.100H	20	51.1524.119H	68
09.2000.301H	26,27,66,69,76	12.1024.012.099	36	15.5801.840H	35	20.5700.001.099	21	51.2491.121H	51
09.2070.101H	26,28,42,60,68	12.1027.001.099	22	15.5811.871H	35	20.5700.002.099	21	51.2491.122H	51
	76	12.1027.002.099	22	15.5811.872H	35	20.5700.003.099	21	51.2493.121H	51
09.2770.001.000	40,75	12.1027.005.099	22	15.5891.611H	53,65	20.5700.004.099	21	51.2493.127H	51
09.2770.210	40	12.1027.006.099	22	15.5891.612H	53,65	20.5700.410H	21	51.2500.127H	60
09.2770.211 + 09.2770.210	40	12.1027.015.099	22	15.5891.721.099	53,55,65	20.5700.420H	21	51.2500.147H	60
09.2910.002.099	72,75	12.1027.016.099	22	15.5891.722.099	53,55,65	20.5750.710.099	44	51.2510.127H	28
09.2910.003.099	40,75	f12.1027.103.099	22	15.5891.741H	53,65	20.5750.720.099	44	51.2510.137H	28
09.2910.004.099	75	12.1027.104.099	22	15.5891.742H	53,65	20.5800.410H	35	51.2510.147H	28
09.2910.005.099	72,75	12.1027.107.099	22	15.6000.001.099	48	20.5800.420H	35	51.2520.127H	60
09.2910.007.000	75	12.1027.108.099	22	15.6000.002.099	48	20.5800.610H	35	51.2520.147H	60
09.3200.220	76	12.1027.203.099	22	15.6000.003.099	48	20.5800.620H	35	51.2530.120H	42
09.3200.320H	76	12.1027.204.099	22	15.6000.004.099	48	20.5800.710H	35	51.2530.140H	42
09.3200.320H	76	12.1027.207.099	22	15.9060.870H	18,23	20.5800.720H	35	51.2540.120H	42
09.3200.420H	26,69,71	12.1027.208.099	22	19.1000.101.099	63	20.5800.750H	35	51.2540.130H	42
09.3200.420H	76	12.1041.001.099	41	19.1000.102.099	63	20.7504.003.001	67	51.2540.140H	42
09.3300.421	76	12.1041.002.099	41	19.1000.103.099	63	20.7504.044.001	67	51.2890.117H	68
09.3400.420	26,66,76	12.1041.003.099	41	19.1000.121.099	63	40.1009.001.000	69	51.2890.147H	68
09.3900.003.000	56,57,61	12.1041.004.099	41	19.1000.122.099	63	40.1009.001.099	69	51.3000.001.001	67
09.5700.001.099	20	12.1041.005.099	41	19.1008.041.099	24	40.1009.002.000	69	51.3000.002.001	67
09.5700.002.099	20	12.1042.001.099	41	19.1008.311.099	24	40.1009.002.099	69	51.3200.147H	26
09.5750.001.099	44	12.1042.002.099	41	19.1012.000.099	48	40.1009.003.099	69	51.3400.147H	26
09.5750.220.099	44	12.3920.001.099	34	19.1012.001.099	48	40.1009.004.099	69	51.3410.127H	26
10.6111.100	28	12.3920.002.099	34	19.1012.002.099	48	40.1009.005.099	69	51.3410.140	26
10.6121.100	26,28	12.3930.001.099	34	19.1012.003.099	48	40.1010.002.099	70	51.3410.147H	26
10.6211.100	28,66	12.3930.002.099	34	19.1013.011.099	37,65	40.1009.421.002	69	51.3412.120H	26
10.6221.100	28,66,68	12.5590.009.099	23	19.1013.012.099	37,65	40.1009.422.002	69	51.3490.110H	51
10.6321.100	26,27	12.5740.002.099	20	19.1018.311.099	72	40.1525.114H	68	51.3490.112H	51
11.1008.001.099	24	13.1024.001.099	36	19.1018.312.099	72	40.2500.222H	60	51.3490.120H	51
11.1036.011.099	71	13.1024.002.099	36	19.1019.013.099	59	40.2500.422H	60	51.3490.122H	51
11.1036.012.099	71	13.1024.003.099	36	19.1019.014.099	59	40.2510.222H	28	51.3495.110H	63
11.1036.013.099	71	13.1024.004.099	36	19.1019.313.099	59	40.2510.322H	28	51.3495.112H	63
11.1036.014.099	71	13.1039.001.099	54	19.1019.314.099	59	40.2510.422H	28	51.3495.120H	63
11.1039.001.099	54	13.1039.002.099	54	19.1020.213.099	37	40.2520.222H	60	51.3495.122H	63
11.1039.002.099	54	13.1043.001.000	63	19.1020.613.099	37	40.2520.422H	60	51.3635.201	68
11.1039.011.099	54	13.1044.001.000	63	19.1024.011.099	36	40.2530.222H	42	51.3635.204	68
11.1039.012.099	54	13.5800.100H	35	19.1024.012.099	36	40.2530.422H	42	51.3635.206	68
11.2770.102	40	13.5890.110.199	53,55,65	19.1024.311.099	36	40.2540.222H	42	51.3636.201	68
11.2770.202	40	13.5890.120.099	53,55,65	19.1024.312.099	36	40.2540.422H	42	51.3636.204	68
11.2770.302	40	13.5890.210.199	53,55,65	19.1036.005.099	71	40.2605.204H	26	51.3636.206	68
11.2770.402	40	13.5890.220.099	53,55,65	19.1027.011.099	22	40.2660.404H	27	51.3640.127H	28
11.2770.920	40	14.5890.100.099	53,55,65	19.1027.012.099	22	40.2665.203H	27	51.3640.137H	28
11.2780.910	39	14.5890.200.099	53,55,65	19.1027.311.099	22	40.2665.204H	27	51.3640.147H	28
11.2780.920	39	15.2240.840H	62	19.1027.312.099	22	40.2665.403H	27	51.3731.325	30
11.2790.001.099	25	15.2711.114	38,73	19.1036.006.099	71	40.2890.222H	66,68	51.3731.326	38,73
11.2790.002.099	25	15.2711.214H	51,63	19.1036.007.099	71	40.2890.322	66	51.3732.325	30
11.2810.200H	50	15.2712.113F	73	19.1036.008.099	71	40.2890.422H	66,68	51.3732.326	38,73
11.2910.001.000	75	15.2712.114	38,73	19.1036.009.099	71	40.3200.422H	26	51.3735.121H	30
11.2910.002.000	75	15.2771.840	40	19.1036.010.099	71	40.3485.403H	19,58	51.3735.124H	30
11.2910.003.000	75	15.2771.870	40	19.1039.011.099	54	40.3485.412H	19,58	51.3735.126H	30
11.2910.004.000	75	15.2780.840	39,41,75	19.1039.012.099	54	40.3605.203H	60	51.3736.121H	30
11.2910.006.000	75	15.2780.841F	39,72,75	19.1039.311.099	54	40.3605.204F	60	51.3736.124H	30
11.2910.007.000	75	15.2780.870	39	19.1039.312.099	54	40.3605.403H	60	51.3736.126H	30
11.2910.008.000	75	15.2780.871F	39	19.1039.411.099	54	40.3640.222H	26,28	51.3801.148H	31
11.2910.009.000	75	15.2810.480H	50	19.1039.412.099	54	40.3640.322H	28	51.3801.168H	31
11.2910.011.002	75	15.3480.840H	19,58	19.1039.811.099	54	40.3640.422H	26,28	51.3802.148H	31
11.2910.012.002	75	15.3491.071H	51,63	19.1039.812.099	54	40.5725.212H	29	51.3802.168H	31
11.3480.100	19,58	15.3491.072H	51,63	19.1043.001.099	63	40.5725.412H	29,62	51.3850.127H	66
11.3730.210H	18,38,68,73	15.3491.371H	51,63	19.1044.001.099	63	40.5735.203H	29	51.3850.137	66
11.3730.310H	30	15.3491.372H	51,63	19.2790.011.099	25	40.5735.403H	29,62	51.3850.147H	66
11.3800.300H	31	15.3702.470H	60	19.2790.012.099	25	51.1009.001.099	69	51.3850.157	66
11.3810.340	31	15.3731.070H	30	19.2790.031.099	25	51.1009.009.099	69	51.3850.16	

# MEKRA-catalogue articles MEKRA-Katalog-Artikel



51.3920.004.099	34	56.3811.168H	31	59.1018.004.099	72	59.2910.008.001	74	61.1042.006.099	41
51.3920.005.099	34	56.3812.128H	31	59.1018.007.099	72	59.2910.009.001	74	61.2530.110H	42
51.3920.012.099	34	56.3812.148H	31	59.1018.008.099	72	59.2910.010.001	74	61.2703.110	79
51.3920.013.099	34	56.3812.168H	31	59.1024.001.099	36	59.2910.012.001	74	61.2703.120	79
51.3920.014.099	34	56.3860.112H	30	59.1024.002.099	36	59.2910.013.001	74	61.2708.842H	79
51.3921.222H	32	56.3860.114H	30	59.1024.005.099	36	59.2910.014.001	74	61.2770.210	40
51.3921.223H	33	56.3861.116H	30	59.1024.006.099	36	59.2910.015.001	74	61.2770.211	40
51.3921.224H	33	56.3862.116H	30	59.1024.009.099	36	59.2910.016.001	74	61.2770.900.099	40
51.3922.222H	32	56.3930.001.099	34	59.1024.010.099	36	59.2910.017.001	74	61.2770.901.099	40
51.3922.223H	33	56.3930.002.099	34	59.1024.013.099	36	59.2910.018.001	74	61.2772.100	40
51.3922.224H	33	56.3930.003.099	34	59.1024.014.099	36	59.2910.019.001	74	61.2772.211.099	40
51.3923.222H	32	56.3930.004.099	34	59.1024.017.099	36	59.2910.020.001	74	61.2910.001.001	75
51.3923.223D	33	56.3931.323H	33	59.1024.019.099	36	59.3491.110H	51	61.2910.002.001	75
51.3923.224H	33	56.3931.343H	33	59.1024.021.099	36	59.3491.120H	51	61.2910.003.001	75
51.3924.223D	33	56.3932.323H	33	59.1024.022.099	36	59.3492.110H	51	61.2910.004.001	75
51.3924.224H	33	56.3932.343H	33	59.1024.023.099	36	59.3492.120H	51	61.2910.005.001	75
51.5524.930H	22,57,61,67	56.3960.148H	45,47	59.1024.024.099	36	59.3601.128H	60	61.2910.006.001	75
51.5720.120H	29	56.5730.120H	29	59.1024.025.099	36	59.3601.178H	60	61.2910.007.001	75
51.5720.140H	29	56.5730.140H	29	59.1024.026.099	36	59.3601.188H	60	61.2910.008.001	75
51.5721.160H	29	56.5790.002.099	34,35	59.1024.027.099	36	59.3602.128H	60	61.2910.021.001	75
51.5722.160H	29	56.5790.003.099	29,32	59.1024.028.099	36	59.3652.128H	27	61.2910.022.001	75
51.5750.001.099	44	56.5790.004.099	29,32,45,47	59.1024.029.099	36	59.3652.148H	27	61.3000.001.001	67
51.5750.002.099	44	56.9065.110	18,23	59.1024.030.099	36	59.3652.168H	27	61.3000.002.001	67
51.5750.003.099	44	58.1016.001.099	78	59.1025.001.099	21,58,62	59.3891.140H	67	61.3480.149H	19,58
51.5750.004.099	44	58.1016.002.099	78	59.1025.002.099	21,58,62	59.3900.123H	57	61.3481.149H	19,58
51.5770.001.099	44	58.1016.003.099	78	59.1027.001.099	22	59.3900.133H	56,61	61.3482.149H	19,58
51.5891.111.199	52,64	58.1016.004.099	78	59.1027.002.099	22	59.3900.143H	56,61	61.3730.324H	18
51.5891.112.199	52,64	58.1016.005.099	78	59.1027.003.099	22	59.3900.223H	57	61.3730.326H	18
51.5891.113.199	52,64	58.1016.006.099	78	59.1027.004.099	22	59.3900.233H	56,61	61.3752.147H	43,50
51.5891.114.199	52,64	58.1017.005.099	70	59.1039.101.099	54	59.3900.243H	56,61	61.3752.167H	43,50
51.5891.211.199	52,64	58.1017.006.099	70	59.1039.104.099	54	59.3900.323	57	61.3770.147H	43,46
51.5891.212.199	52,64	58.1017.011.099	70	59.1039.105.099	54	59.3900.333	56,61	61.3772.147H	43,46
51.5891.213.199	52,64	58.1017.012.099	70	59.1039.125.099	54	59.3900.343	56,61	61.3773.147H	43,46,50
51.5891.214.199	52,64	58.1017.013.099	70	59.1039.155.099	54	59.3900.423	57	61.3780.100H	43,46,47,50
51.5891.311.199	52,64	58.1017.014.099	70	59.1039.201.099	54	59.3900.433	56,61	61.3780.147H	46
51.5891.312.199	52,64	58.1017.015.099	70	59.1039.204.099	54	59.3900.443	56,61	61.3782.147H	46
51.5891.313.199	52,64	58.1017.016.099	70	59.1039.205.099	54	59.3962.210H	45	61.3782.167H	46
51.5891.314.199	52,64	58.2704.044	79	59.1039.225.099	54	59.3964.210H	45	61.3783.147H	46
51.5891.411.199	52,64	58.2704.048	79	59.1039.255.099	54	59.3965.210H	47	61.3783.167H	46
51.5891.412.199	52,64	58.2704.051H	79	59.1039.501.099	55	59.3980.011H	50	61.3860.100	18,23
51.5891.413.199	52,64	58.2704.070	79	59.1039.525.099	55	59.3980.012	50	61.3860.214H	18
51.5891.414.199	52,64	58.2704.086	79	59.1039.551.099	55	59.3980.021H	50	61.3865.124H	18
51.5892.111.199	52,64	58.2704.088	79	59.1039.558.099	55	59.3980.022H	50	61.3900.100H	56,57,61
51.5892.112.199	52,64	58.2704.093	79	59.1039.575.099	55	59.3980.111	50	61.3900.110H	56,57,61
51.5892.113.199	52,64	58.2705.001H	79	59.1039.601.099	55	59.3980.112	50	61.3900.120H	56,57,61
51.5892.211.199	52,64	58.2705.003	79	59.1039.625.099	55	59.3980.121	50	61.3900.130H	56,57,61
51.5892.212.199	52,64	58.3752.100	43	59.1039.651.099	55	59.3980.122	50	61.3910.110H	57
51.5892.213.199	52,64	58.3752.200	43	59.1039.658.099	55	59.3980.132	50	61.3910.120H	57
51.5892.311.199	52,64	58.3781.100H	46	59.1039.675.099	55	59.3980.141	50	61.3911.110H	56,61
51.5892.312.199	52,64	58.3781.200H	46	59.1039.701.099	55	59.3980.142	50	61.3911.120H	56,61
51.5892.313.199	52,64	58.3783.200H	46	59.1039.751.099	55	59.5520.130H	21	61.5590.001.099	20,75
51.5892.411.199	52,64	58.3783.300H	46	59.1039.801.099	55	59.5520.230H	21	61.5700.210H	20
51.5892.413.199	52,64	58.5700.003.002	21	59.1039.851.099	55	59.5520.530H	66	61.5700.310.099	20
51.5893.111.199	52,64	58.5700.004.002	21	59.1041.001.099	41	59.5524.530H	67	61.5710.210H	20
51.5893.112.199	52,64	58.5700.001.099	21	59.1041.002.099	41	59.5524.648.099	57,61	61.5710.310.099	20
51.5893.113.199	52,64	58.5701.104.099	21	59.1041.003.099	41	59.5524.649.099	57	61.5721.004.099	29,62
51.5893.211.199	52,64	58.5710.001.099	21	59.1041.004.001	41	59.5580.147H	22,58	61.5721.005.099	62
51.5893.212.199	52,64	58.5713.114.099	21	59.1042.001.099	41	59.5580.247H	22,58,61	61.5721.006.099	62
51.5893.213.199	52,64	58.5750.005.199	44	59.1042.002.099	41	59.5581.100H	59	61.5731.001.099	62
51.5894.112.199	52,64	58.5750.012.199	44	59.1042.003.099	41	59.5590.013.099	23	61.5740.001.099	20
51.5894.212.199	52,64	58.5752.100H	44	59.1042.004.099	41	59.5590.014.099	23	61.5750.100H	44
51.5894.310.199	52,64	58.5752.200H	44	59.1042.005.099	41	59.5595.131H	20	61.9065.114H	18,23
51.5894.410.199	52,64	58.5752.300H	44	59.2652.110H	27	59.5595.132H	20		
51.5895.312.199	52,64	58.5752.400E	44	59.2710.401H	73	59.5595.235H	20		
51.5895.412.199	52,64	58.5800.101H	35	59.2710.402H	73	59.5595.236	20		
51.7504.044.001	67	58.5800.102H	35	59.2710.406	73	59.5595.331H	20		
55.1008.001.099	25	58.5800.201H	35	59.2710.454	73	59.5595.332	20		
55.1008.002.099	25	58.5800.202H	35	59.2712.111	38	59.5800.101H	35		
55.1008.003.099	25	59.1005.001.099	21	59.2712.114	38	59.5800.102H	35		
55.1008.004.099	25	59.1005.002.099	21	59.2762.101	38	59.5800.121H	35		
55.3000.001.001	67	59.1005.003.099	59	59.2762.322	38	59.5800.122H	35		
55.3000.002.001	67	59.1005.011.099	23	59.2762.422	38	59.5800.201H	35		
55.3000.003.001	67	59.1008.005.099	24	59.2770.210.099	40	59.5800.202H	35		
55.3000.004.001	67	59.1008.006.099	24	59.2770.211.099	40	59.5800.203H	35		
56.1004.001.099	45,47,48	59.1008.011.099	24	59.2770.310.099	40	59.5800.221H	35		
56.1008.001.099	24	59.1008.012.099	24	59.2771.210.099	40	59.5800.222H	35		
56.1008.002.099	24	59.1008.017.099	24	59.2780.120.099	39	59.5800.223H	35		
56.1008.003.099	24	59.1008.018.099	24	59.2780.130	39	59.5800.302H	35		
56.1008.004.099	24	59.1008.045H	24	59.2780.140.001	39	59.5800.322H	35		
56.1020.015.099	37	59.1008.046H	24	59.2780.150.001	39	59.5800.402H	35		
56.1020.017.099	37	59.1008.051H	24	59.2780.160.001	39	59.5800.422H	35		
56.1020.018.099	37	59.1008.052H	24	59.2780.170.001	39	59.1039.151.099	54		
56.1020.019.099	37	59.1008.057H	24	59.2780.180.001	39	59.1039.154.099	54		
56.1020.020.099	37	59.1008.058H	24	59.2780.200.001	39	59.1039.158.099	54		
56.2600.127H	26	59.1017.003.099	70	59.2780.230	39	59.1039.175.099	54		
56.2600.147H	26	59.1017.004.099	70	59.2781.120	39	59.1039.251.099	54		
56.2650.121H	27	59.1017.005.099	70	59.2810.111H	50	59.1039.254.099	54		
56.2660.001.099	27	59.1017.006.099	70	59.2810.113H	50	59.1039.258.099	54		
56.2660.002.099	27	59.1017.008.099	70	59.2910.001.001	74	59.1039.275.099	54		
56.2660.004.099	27	59.1017.009.099	70	59.2910.002.001	74	61.1009.001.099	69		
56.2660.127H	27	59.1017.018.001	70	59.2910.003.001	74	61.1009.002.099	69		
56									

# Homologationsnummern List of homologation numbers

e	E	Typ · type tipo · тип	Tip	
II	e1	03*0002	575	44
IV	e1	03*0003	577	44
V	e5	02*0003	156/6 BO	--
IV	e11	03*0003	224	62
IV	E11	02*0003	224	62
V	e5	02*0004	156/6 BO	--
V	e11	03*0004	224	62
VI	e11	03*0005	224	62
VI	E11	02*0005	224	62
III	e1	03*0006	589	52,53,64,65
III	e1	03*0007	570	20
IV	e1	03*0008	571	20
II	e1	03*0009	390	22,56,57,61
IV	e1	03*0010	390	22,56,57,61
V	e1	03*0011	558	22,58,59,61
V	e1	02*0013	379-1	--
IV	e1	03*0014	906	18,23
V	e1	03*0015	365-1	27
			394, 394-1	--
VI	e1	03*0016	389	67
VI	e1	03*0017	396	45,47
II	e1	03*0018	378-1	46
IV	e1	02*0019	377-1	43,46
II	e1	03*0022	271	38,73
			271-K	--
			276	38
			363	23,68
			373	18,30
			380-1	31
IV	e1	03*0023	386, 386-1	--
			381-1	31
II	e1	03*0024	392-1	33
II	e1	03*0024	392-2	34
IV	e1	03*0025	393-1	33
IV	e1	03*0025	393-2	34
II	e1	03*0031	572	29,62
IV	e1	03*0032	573	29,62
V+VI	e1	03*0033	552-1	21,57,61,66,67
V+VI	e1	03*0037	390	22,56,57,61
V	e1	02*0039	360-1	60
VI	e1	03*0042	287-1 / 288-1	--
V	e1	03*0044	287-1 / 288-1	--
II	e1	03*0047	273	--
			395	50
II	e1	03*0048	340	26
II	e11	03*0050	400	59
II	E11	02*0050	400	59
IV	e11	03*0051	400	59
IV	E11	02*0051	400	59
II	e1	03*0060	364-1	--
II	E1	01*00620	273	--
			395	50
II	e1	03*0082	274	--
II	e1	03*0084	277	40
II	e1	03*0088	271	38,73
			271-K	--
			276	38
			363	23,68
			373	18,30
			380-1	31
II	e1	03*0097	580	35
IV	e1	03*0098	580	35
V	e1	03*0109	579	29,32,34,35,45
			47	--
II	e1	03*0115	380-1	31
II	e1	03*0123	375	43
			398	50
II	e1	03*0124	281	50
II	e1	03*0128	278	39
IV	e1	03*0129	278	39
V	e1	03*0174	395	50
V	e1	03*0184	348	19,19,58,58
V	e1	03*0185	348	19,19,58,58
II	e1	03*0188	374-1	--
IV	E5	01*019	156/6 BO	--
VI	e1	03*0196	559	21
V	E5	01*020	156/6 BO	--
IV	e1	03*0234	371-1	--
II	e1	03*0242	1000-1	--
IV	e1	03*0243	1000-2	--
V	e1	03*0244	1001	--
VI	e1	03*0245	1002	--
II	e1	03*0257	385-1	--
II	E1	01*0376	258	--
II	E1	01*0377	258	--
II	e1	02*0382	385	66
II	e1	02*0384	349	51,63
II	E1	01*0384	349	51,63
II	e1	01*0391	282	--
II	e1	01*0392	283	--
IV	E1	01*0392	283	--
IV	e1	01*0394	367	--
IV	E1	01*0394	367	--
II	e1	01*0395	368	--
II	e1	02*0418	349	51,63
II	e1	01*0423	271	38,73
			271-K	--

e	E	Typ · type tipo · тип	Tip	
			276	38
			363	23,68
			373	18,30
			380-1	31
II	E1	01*0423	271	38,73
			271-K	--
			276	38
			363	23,68
			373	18,30
			380-1	31
IV	e1	02*0424	386, 386-1	--
			381, 386-1	--
IV	E1	01*0424	386, 386-1	--
			381	--
II	e1	02*0447	281	50
II	E1	01*0447	281	50
IV	e1	02*0448	281	50
II	E1	01*0448	281	50
IV	e1	02*0462	377	43,46
IV	E1	01*0462	377	43,46
II	e1	02*0463	378	46
II	E1	01*0463	378	46
V	e1	02*0464	379	--
V	E1	01*0464	379	--
II	e1	01*0469	385	66
II	E1	01*0469	385	66
II	e1	02*0487	372	--
IV	e1	02*0488	372	--
II	e1	02*0505	375	43
			398	50
II	E1	01*0505	375	43
			398	50
II	e1	02*0524	271	38,73
			271-K	--
			276	38
			363	23,68
			373	18,30
			380-1	31
II	E1	01*0524	271	38,73
			271-K	--
			276	38
			363	23,68
			373	18,30
			380-1	31
II	e1	02*0529	380-1	31
III	e1	02*0569	198	--
III	E1	01*0569	198	--
II	e1	02*0620	273	--
			395	50
II	e1	02*0646	392	32
II	E1	01*0646	392	32
IV	e1	02*0647	393	32
V	e1	02*0647	284	--
IV	E1	01*0647	393	32
II	e1	02*0662	374 (LDV)	--
II	e1	02*0688	405	--
IV	e1	02*0689	406	--
II	e1	02*0740	550	--
IV	e1	02*0741	551	--
V	e1	02*0742	552	21
V	E1	01*0742	552	21
II	e1	01*0798	901 (Iveco)	--
V	E1	02*0894	552-1	21,57,61,66,67
III	E1	02*0902	589	52,53,64,65
II	E1	02*0905	271	38,73
			271-K	--
			276	38
			363	23,68
			373	18,30
			380-1	31
IV	E1	02*0906	906	18,23
II	E1	02*0910	274	--
V	E1	02*0912	558	22,58,59,61
IV	E1	02*0913	390	22,56,57,61
II	E1	02*0914	390	22,56,57,61
II	E1	02*0915	227	--
IV	E1	02*0916	390	22,56,57,61
IV	E1	02*0917	573	29,62
II	E1	02*0918	572	29,62
V	E1	02*0922	365-1	27
			394, 394-1	--
II	E1	02*0923	271	38,73
			271-K	--
			276	38
			363	23,68
			373	18,30
			380-1	31
IV	E1	02*0924	393-1	33
IV	E1	02*0924	393-2	34
II	E1	02*0925	392-1	33
II	E1	02*0925	392-2	34
II	E1	02*0926	273	--
			395	50
II	E1	02*0929	580	35
IV	E1	02*0930	580	35
VI	E1	02*0937	389	67
II	E1	02*0939	380-1	31

e	E	Typ · type tipo · тип	Tip	
II	E1	02*0941	375	43
			398	50
II	E1	02*0942	281	50
II	E1	02*0951	278	39
IV	E1	02*0952	278	39
V	E1	02*0973	360-1	60
V	E1	02*0998	395	50
V	e1	*10025	156/4 BO	--
I	e1	02*10041	202	--
II	e1	*10042	152 AS	--
III	E1	02*1020	922, 923	--
V	e3	03*1021	463-1	--
V	E3	01*1021	463-1	--
III	E1	02*1021	922, 923	--
IV	e3	03*1022	462	--
IV	E3	01*1022	462	--
IV	E3	02*1023	348	19,19,58,58
V	e3	03*1031	1008	24,24,25
II	e3	03*1034	1008	24,24,25
IV	e1	02*1035	349 TW	51,63
IV	e3	03*1036	1008	24,24,25
VI	e1	02*1039	559	21
VI	e3	03*1042	1008	24,24,25
II	e9	01*1047	271	38,73
			271-K	--
			276	38
			373	18,30
IV	e9	01*1054	386	18,30
II	e9	01*1063	460	--
II	e9	01*1073	271	38,73
			271-K	--
			276	38
			373	18,30
IV	e9	01*1074	386	18,30
V	e9	01*1075	463-1	--
IV	e1	02*11001	260	26
II	e1	*11002	156/6 BO	--
IV	e1	02*11003	283	--
IV	e1	*11004	266	27
IV	e1	02*11005	268	--
IV	e1	*11006	267	--
IV	E1	02*11007	266	27
IV	E1	02*11008	266, 266-1	--
IV	E1	01*11008	266, 266-1	--
IV	E1	02*11009	266	27
IV	e1	02*11010	462	--
IV	E1	01*11010	462	--
IV	e1	02*11011	367	--
IV	E1	01*11011	367	--
IV	e1	02*11012	285	--
IV	E1	01*11012	285	--
IV	e1	02*11013	268	--
IV	E1	02*11014	267	--
IV	e1	*11015	266	27
IV	e1	02*11016	371	60
IV	E1	01*11016	371	60
II	e4	02*1104	110	--
II	E4	01*1104	110	--
II	e4	01*1106	257	--
II	E1	02*1112	600	48
IV	E1	02*1113	600	48
VI	E1	02*1114	603	--
II	E1	02*1144	575	44
IV	E1	02*1145	577	44
II	e6	01*116	250	60
II	E1	02*1165	1009 / 1017	--
V	E1	02*1178	1014	--
V	E1	02*1178	1004	45,47,48
V	E1	02*1179	579	29,32,34,35,45
			47	--
V	e1	02*12001	156/5 BO	--
V	e1	*12002	156/2 BO	--
V	e1	02*12003	284	--
V	E1	01*12003	284	--
V	e1	*12004	156/6 BO	--
V	e1	*12005	265	27
V	e1	02*12006	265	27
V	e1	02*12007	265	27
V	E1	01*12007	265	27
V	e1	02*12008	265	27
V	e1	02*12009	463-1	--
V	E1	01*12009	463-1	--
II	e4	02*12011/1202	253	42
II	e4	02*12011/1202	254	42
II	e4	02*12011/1202	258	--
V	e1	02*12010	269	--
V	E1	01*12010	269	--
V	e1	02*12011	361	--
V				



## List of homologation numbers Homologationsnummern

e	E	Typ · type tipo · тип	Tip	
II	E1	01*14069	258	--
II	e1	01*14070	254 +	--
II	e1	01*14071	255	--
			256	--
II	e1	02*14072	258	--
II	e1	02*14073	40.4495.222	--
			253	42
II	e1	01*14075	251	28
II	e1	02*14076	152 AS	--
II	e2	02*14080	364	28
II	e1	02*14082	364	28
II	E1	01*14082	364	28
II	e1	02*14083	282	--
II	E1	01*14083	282	--
II	e1	02*14084	282	--
II	e1	*14085	340 / 341	--
II	e1	*14086	253	42
II	e1	02*14087	340 / 341	--
II	e1	02*14088	249 L	--
II	e1	02*14089	252	60
II	E1	01*14089	252	60
II	e1	02*14090	251	28
II	e1	*14091	253	42
II	e1	02*14092	254	42
II	e1	*14093	253	42
II	e1	*14094	253	42
II	e1	01*14095	254	42
II	e1	01*14096	253	42
II	e1	02*14097	258	--
II	E1	01*14097	258	--
II	e1	02*14098	340 / 341	--
II	E1	01*14098	340 / 341	--
II	e1	02*14099	254	42
II	e1	02*14100	330 / 331	--
II	E1	01*14100	330 / 331	--
II	e1	02*14101	340 / 341	--
II	e1	02*14102	460	--
II	E1	01*14102	460	--
II	e1	02*14103	461	--
II	E1	01*14103	461	--
II	e1	02*14105	368	--
II	e1	02*14108	254	42
II	e1	02*14109	254	42
II	e1	02*14111	385 +	--
II	e1	02*14112	258	--
II	e1	02*14117	280	--
II	E1	01*14117	280	--
II	e1	01*14119	249 L	--
II	e1	02*14121	366	--
II	e1	02*14122	364/1	--
II	e1	02*14123	368	--
II	E1	01*14123	368	--
II	e1	01*14124	340 / 341	--
II	e1	02*14125	370	60
II	E1	01*14125	370	60
II	e1	02*14126	371	60
II	E1	01*14126	371	60
II	e1	02*14142	364	28
II	E13	02*1456	38.3730.410H	--
IV	e13	03*1457	906	18, 23
IV	e1	02*1550	264	--
V	e1	02*1551	264	--
II	e13	02*1558	253	42
III	e1	01*17023	249 A	--
			249 K	51
II	e1	*17087	151 K	--
III	e1	01*17098	249 A	--
			249 K	51
II	e1	*17105	156/4 BO	--
II	e1	*17140	149 K	--
II	e1	01*17149	198	--
III	e1	01*17194	200 (Ford)	--
III	e1	02*17324	196	--
III	e1	02*17335	249 L	51
II		*18792	572	29, 62
II	e4	01*2067	254	42
II	e4	02*2069	259	--
II	E4	01*2069	259	--
II	E6	00*208	250	60
II	e4	01*2083	252	60
II	e1	*2407	244 A ++	--
II	e4	03*2563	373	18, 30
II	E4	02*2563	373	18, 30
II	e1	*2901	156/6 BO	--
II	e3	*30011	472	--
II	e3	*30595	467	--
II	e2	01*307	291	74, 75
II	e3	*32806	467	--
II	e3	*32906	472	--
II	e3	*32908	474 (Iveco)	--
II	e3	*33488	473 (Iveco)	--
II	e3	*33491	472	--
II	e3	*34767	472	--
II	e3	*35216	472	--
II	e3	*35433	472	--
II	e3	*35911	474 (Iveco)	--
II	e3	01*36030	474 (Iveco)	--

e	E	Typ · type tipo · тип	Tip	
II	e3	*36709	340 / 341	--
II	e3	*36710	473 (Iveco)	--
II	e3	*36726	600 (Fiat)	--
II	e11	01*3701	255	--
II	e11	01*3706	364	28
II	e11	01*3709	257	--
II	e11	01*3716	253	42
II	e11	01*3717	252	60
II	e3	*37469	475 (Iveco)	--
II	e3	*38090	472	--
III	e	01*38334	600 (Fiat)	--
II	e3	01*38662	475 (Iveco)	--
II	e3	01*3890	472	--
II	e3	02*3890	472	--
II	e3	01*38930	475 (Iveco)	--
II	e3	01*38961	475 (Iveco)	--
II	e3	01*39267	475 (Iveco)	--
II	e3	02*39267	475 (Iveco)	--
II	e3	01*39542	475 (Iveco)	--
II	e3	*40142	250	60
II	e3	01*40458	473 (Iveco)	--
II	e3	02*40458	473 (Iveco)	--
II	e3	01*40459	473 (Iveco)	--
II	e3	02*40459	473 (Iveco)	--
II	e1	*4051	253	42
II	e3	*41511	475 (Iveco)	--
II	e3	01*41877	474 (Iveco)	--
II	e3	*42453	257	--
II	e3	01*42704	253	42
II	e3	01*42928	258	--
II	e3	02*43355	264	--
II	e3	02*43356	264	--
II	e3	02*43360	472	--
II	e3	*43611	364	28
II	E9	02*4395	286-1	--
II	e3	*44994	258	--
II	e17	00*46002	257	--
II	e3	02*46315	472	--
II	e3	02*46656	460	--
II	E3	01*46656	460	--
V	e3	02*46657	463-1	--
IV	e3	02*46658	462	--
IV	E3	01*46658	462	--
II	e3	02*46919	461	--
II	E3	01*46919	461	--
IV	e11	01*5002	156/6 BO	--
II	e2	02*5004	348	19, 19, 58, 58
IV	e13	01*51370	264	--
II	e11	01*5340	253	42
II	e11	01*5343	257	--
II	e11	01*5383	258	--
II	e11	01*5387	255	--
II	e11	01*5392	364	28
II	e11	01*5393	254	42
II	e11	01*5394	252	60
II	e11	01*5395	251	28
II	e11	01*5396	341	26
IV	e11	01*5398	261	--
IV	e11	01*5399	266	27
IV	e11	01*5420	260	26
II	e11	01*5421	249 L	51
V	e11	01*5422	265	27
II	e11	01*5464	254	42
IV	e11	01*5465	156/6 BO	--
III	e11	01*5502	200 (Ford)	--
II	e3	02*56297	348	19, 19, 58, 58
II	E3	01*56297	470	--
II	e3	02*57571	461	--
II	E3	01*57571	461	--
II	e3	02*58121	460	--
II	E3	01*58121	460	--
IV	e3	02*58232	462	--
IV	E3	01*58232	462	--
II	e11	03*6208	224	62
II	E11	02*6208	224	62
IV	e11	03*6209	224	62
IV	E11	02*6209	224	62
IV	e9	03*6450	580	35
IV	e6	02*6565	261	--
II	e6	02*6566	252	60
II	E6	00*6566	252	60
II	e9	02*6569	373	18, 30
II	E9	02*6569	373	18, 30
IV	E3	02*7010	462	--
IV	E3	02*7012	462	--
II	e3	03*7018	460	--
V	e3	03*7024	463-1	--
II	E6	00*7059	253	42
II	e6	02*7060	253	42
II	e2	02*717	289	68
II	e2	00*718	249 L	--
II	E13	08*7293	253	42
II	e2	02*739	253	42
II	e2	02*740	258	--
II	e2	02*752	286	--
II	E2	00*752	286	--
IV	E2	00*753	287-1	--

e	E	Typ · type tipo · тип	Tip	
II	E2	00*759	254	42
V	e6	02*8104	263	--
III	e13	00*86246	39.3730.210H	--
			39.3730.410H	--
IV	e13	01*87290	264	--
IV	E13	01*87290	264	--
V	e13	01*87291	264	--
IV	E13	01*87291	264	--

## NEW

II	E1	02*0902	1039	55
II	E1	021108	1000	63
II	E1	021109	1000	63
II	e1	03*0242	1000	63
II	e1	03*0243	1000	63
II	E1	041469	1039	54
II	E1	041480	1041	41
II	E1	041481	1041	41
II	E1	041540	1000	63
II	E1	041541	1000	63
II	E1	041543	1024	36
II	E1	041619	1027	22
IV	E1	041620	1027	22
III	E1	02*0902	1039	55
IV	E1	041542	1024	36
IV	E1	041482	1041	41
V	E1	041389	1020	37



**MEKRA Lang GmbH & Co. KG** hat diesen Katalog sorgfältig verfasst. Das Unternehmen entbehrt sich jeglicher Verantwortung für eventuelle Fehler oder Auslassung hinsichtlich Schemen, Zeichnungen, Übereinstimmung mit O.E. Codes usw. und behält sich das Recht vor, ohne Ankündigung, am Inhalt Veränderungen vorzunehmen. Anmerkungen, Fehlerhinweise und weitere Anregungen seitens der Kunden werden gerne entgegen genommen, um die nächste Ausgabe des Kataloges effizienter zu gestalten.

Die Vervielfältigung, auch teilweise, des urheberrechtlich geschützten Inhalts des vorliegenden Kataloges ist ohne schriftliche Genehmigung durch die MEKRA Lang GmbH & Co. KG untersagt.

Sämtliche im Katalog genannten Sachnummern der Fahrzeughersteller und deren Markennamen sowie Prüfnummern anderer Spiegelhersteller dienen lediglich zu Vergleichszwecken.



**MEKRA Lang GmbH & Co. KG** has devoted its best attention to the editing of this catalogue; it nevertheless declines any responsibility for possible mistakes or omissions regarding figures, drawings, correspondence with O.E. codes etc. and it reserves the right to modify the contents without prior notice. Users' comments, reports of inaccuracies or any other suggestions which may in any way improve the next edition of this catalogue are warmly welcomed.

It is forbidden to reproduce, even partially, the contents of this catalogue without prior written consent of MEKRA Lang GmbH & Co. KG, who will protect its right in accordance with the law.

All the vehicle manufacturers' reference numbers, mentioned in the catalogue, as well as their brand names and approval numbers of other mirror manufacturers are only for identification purposes.

# Vergleichsliste nach OE-Nummern Cross-reference-table

OE		
<b>Agco</b>		
F743810150020	40.1009.421.002	69
F743810150030	40.1009.422.002	69
<b>Adria Mobil</b>		
9090 83003 00	20.2710.650	39
9095 83001 00	59.2760.005.001	--
9095 83001 00 A	59.2761.302	--
9095 83002 00	59.2760.006.001	--
9095 83010 00	59.1018.001.099	72
9095 83011 00	59.1018.002.099	72
9095 83012 00	12.1018.001.099	72
9095 83013 00	12.1018.002.099	72
9095 83014 00	12.1018.007.099	72
9095 83015 00	12.1018.009.001	72
9095 83016 00	12.1018.010.001	72
9095 83017 00	09.2910.005.099	72,75
9095 83018 00	09.2910.002.099	72,75
9095 83021 00	59.1018.025.001	--
RD 322 077 0	11.3730.210H	18,23,38,68,73
RD 322 244 0	19.1018.311.099	72
<b>Bürstner</b>		
202204008	11.3730.210H	18,23,38,68,73
2193829	12.1018.001.099	72
2193831	12.1018.002.099	72
2193831 MIT ANT	12.1018.012.001	--
2193839	12.1018.009.001	72
2193840	12.1018.010.001	72
2193841	12.1018.007.099	72
2218516	09.2910.002.099	72,75
2218519	09.2910.005.099	72,75
2247710	59.1018.021.001	--
2247727	59.1018.022.001	--
2247751	59.1018.023.001	--
2276379	59.1018.007.099	72
2304574	12.1018.005.099	72
2613741	59.1018.025.001	--
Z60000	20.2710.650	39
Z98889	51.3200.147H	26
Z98892	58.2481.012	--
Z98893	58.2481.011H	--
68152322	59.2762.120	--
70025517	59.2910.003.001	74
70026237	59.2910.500.001	--
70026787	59.2781.120	39
70026788	20.2710.630	--
70026789	59.2910.017.001	74
70026790	61.2910.005.001	75
70026792	09.2910.002.099	72,75
70027178	61.2910.006.001	75
70027535	55.2561.010	--
70027665	51.2540.140H	42
70028068	61.2530.110H	42
70028741	55.2561.110	--
70029007	59.2770.210.099	40
70029251	15.2780.840	39,41,75
70029917	19.2910.001.099	41,75
70029941	15.2780.840	39,41,75
70029942	15.2780.870	39
70030418	59.2780.110	--
70030686	11.2910.007.000	75
70030687	11.2910.006.000	75
70030868	20.2780.631	--
70030875	19.2910.002.099	41,75
70030923	59.2780.120.099	39
70031268	11.2910.002.000	75
70031577	11.2910.001.000	75
70031996	11.2910.008.000	75
70032095	11.2910.003.000	75
70032122	61.2910.011.002	--
70032360	59.2910.014.001	74
70032377	59.2910.013.001	74
70033394	59.2910.009.001	74
70034438	61.2910.012.002	--
70034479	19.2910.001.099	41,75
70034480	19.2910.002.099	41,75
70034551	59.2780.160.001	39
70036218	61.2910.010.002	--
70036219	11.2910.011.002	--
70036220	61.2910.009.002	--
70036705	15.3802.840H	23,68
70037106	20.2710.620	38,39,77
70037291	11.2910.012.002	75
<b>Carthago</b>		
118000	59.2743.332	--
118015	59.2743.322	--
118016	20.2710.121	73
118017	20.2710.630	--
118023	20.2710.111H	73
118029	20.2710.200H	38,73
120565	56.3491.110H	51,63
120666	56.3492.110H	51,63
201619	12.1018.001.099	72
201620	12.1018.002.099	72
201621	12.1018.007.099	72
201622	12.1018.007.099	72

OE		
<b>Carthago</b>		
201623	12.1018.008.000	--
201624	12.1018.008.000	--
201931	09.2910.004.099	75
201932	15.2780.841F	39,72,75
201933	19.1018.311.099	72
201934	19.1018.312.099	72
203722	59.2910.019.001	74
203723	59.2910.020.001	74
207192	59.1018.007.099	72
207193	59.1018.008.099	72
207194	12.1018.005.099	72
207195	12.1018.009.001	72
207196	12.1018.010.001	72
107977	51.1009.017.099	69
110485	51.1009.246.001	--
112137	51.2510.127H	28
112415	55.2020.171	--
372807603	511.009.025.099	--
3728076-03	51.1009.025.099	69
<b>Case New Holland (CNH)</b>		
00437650	51.3850.227	66
47922739	51.1036.009.099	71
47922741	51.1036.010.099	71
47922743	51.1036.007.099	71
47922744	51.1036.008.099	71
48025196	19.1036.005.099	71
48025209	19.1036.006.099	71
<b>Caterpillar</b>		
236-5334	09.2500.300	--
290-5544 / 319-6789	51.3635.201	23,68
294-1991 / 316-6791	51.3635.204	23,68
294-1992	51.3636.204	23,68
308-3844	15.3731.470H	18,38,73
319-6787	11.3730.210H	18,23,38,68,73
3196788	51.3636.201	23,68
319-6790	51.3636.204	23,68
372-8075	51.1009.017.099	69
372-8076	51.1009.246.001	--
4153114	56.2660.147H	27
4362886	51.1009.027.001	--
436-2886	51.1009.027.099	69
4362887	51.1009.242.001	69
436-2887	51.1009.242.099	69
436-2890	20.1016.004.000	78
438-6751	09.3200.340	--
443-2540	51.1009.248.001	--
4432541	51.1009.243.001	--
443-2541	51.1009.244.001	--
508-0795 ALT	51.1009.009.099	69
526-5057	51.1009.001.099	69
<b>Claas</b>		
11578380	40.1009.004.099	69
11578530	11.1009.004.000	--
11578540	51.1009.048.099	--
11578550	40.1009.002.099	69
11617700	11.1036.011.099	71
11617720	11.1036.012.099	71
11617730	19.1036.007.099	71
11617740	19.1036.008.099	71
11653120	40.1009.001.000	69
11653140	40.1009.421.002	69
11653170	40.1009.422.002	69
11654100	51.1009.001.099	69
11654110	61.1009.001.099	69
11654120	61.1009.002.099	69
11683170	40.1009.002.000	69
11683190	51.1009.049.099	69
1817890	11.3400.510	--
21971360	51.1009.097.099	69
22332170	51.1009.113.099	69
26079370	51.1036.023.099	71
26079500	51.1036.024.099	71
26143870	51.1009.017.099	69
5591600	56.2660.003.001	--
5806090	40.3300.318	--
5854370	51.3300.137	--
6259300	40.3305.218	--
6439980	56.2650.121H	27
<b>Concorde</b>		
248268	59.2910.013.001	74
248269	59.2910.014.001	74
28421	15.2780.840	39,41,75
284213	59.2910.019.001	74
284214	59.2910.020.001	74
284215	59.2910.001.001	74
284215-01	11.2910.011.002	75
284215-03	61.2910.011.002	--
284215-07/28421	19.2910.001.099	41,75
284215-10	15.2780.840	39,41,75
284215-10/28421	15.2780.840	39,41,75
284216	59.2910.002.001	74
284216-01	11.2910.012.002	75
284216-02	11.2910.008.000	75
284216-03	61.2910.012.002	--

OE		
<b>Concorde</b>		
284217	61.2910.021.001	75
284218	61.2910.022.001	75
284217-3	61.2770.901.099	40
284221	09.2910.002.099	72,75
284222	20.2710.650	39
284223	20.2710.630	--
284224	59.2780.130	39
2842241	11.2780.910	39
284225	59.2780.230	39
2842251	11.2780.920	39
284226	15.2711.114	38,73
284228	15.2712.114	38,73
284230	59.2710.401H	73
284232	59.2710.402H	73
284233	59.2710.406	73
284237	20.2710.500	--
2842372	11.3730.210H	18,23,38,68,73
284240	20.2480.216H	38,50,73,77
284242	20.2480.217H	38,50,73,77
284248	15.3731.470H	18,38,73
284260	59.1018.003.099	72
284261	59.1018.004.099	72
284262	12.1018.001.099	72
284263	12.1018.002.099	72
284264	12.1018.003.099	72
284265	12.1018.009.001	72
284266	12.1018.010.001	72
284267	09.2910.005.099	72,75
284273	59.2910.009.001	74
284274	59.2910.010.001	74
284277	59.2910.017.001	74
284278	59.2910.018.001	74
284281	19.2910.002.099	41,75
284282	11.2910.016.000	--
284283	11.2910.017.000	--
284284	11.2910.014.000	--
<b>DAF</b>		
1401046	59.5580.147	--
1404849 / 1796325	40.3485.403H	19,58
1404868	61.3482.149H	19,58
1404871	61.3480.149H	19,58
1405295	61.3480.149H	19,58
1405350	61.3482.149H	19,58
1409570	59.5580.147	--
1409962	59.5580.247H	22,58,61
1425104	61.3730.324H	18
1425105	61.3730.326H	18
1425108	61.3860.214H	18
1425109	15.3731.470H	18,38,73
1425111	15.3861.114H	18
1425113	11.3730.210H	18,23,38,68,73
1425114	11.3860.500H	18
1525537	59.5520.530H	66
1525547	59.3652.167H	--
1525548	59.3652.147H	--
1525593	56.1561.116H	--
1525594	56.1561.115H	--
1525630	51.3640.127	--
1525672	51.1523.111H	--
1525673	51.1522.211H	--
1525685	40.3200.422H	26
1526649	59.5580.247H	22,58,61
1527629		

## Cross-reference-table Vergleichsliste nach OE-Nummern

OE		
DAF		
1692557	61.5700.210H	20
1698180	20.5521.100H	20
1700265	59.3900.133H	56,61
1700269	59.3900.233H	56,61
1700303	59.3900.143H	56,61
1700306	59.3900.243H	56,61
1701288	59.5524.648.099	57,61
1704604	59.3900.243H	56,61
1704605	59.3900.233H	56,61
1704627	59.5524.648.099	57,61
1709389	59.1025.002.099	21,58,62
1709390	59.1025.001.099	21,58,62
1733892	58.3900.143H	--
1733893	58.3900.243H	--
1735519	61.3900.110H	56,57,61
1735520	61.3900.120H	56,57,61
1735521	61.3900.100H	56,57,61
1735522	61.3911.110H	56,61
1735523	61.3911.120H	56,61
1736853	58.3900.233H	--
1736854	58.3900.133H	--
1736865	15.3911.872H	56,61
1736879	15.3911.871H	56,61
1736883	11.3910.200H	56,61
1736884	11.3900.200H	56,61
1736891	08.5752.024.099	39,40,56,57,61
1736892	08.5752.024.099	39,40,56,57,61
1736923	20.3900.520H	56,57,61
1736924	20.3900.510H	56,57,61
1736953	58.3900.233H	56,61
1736954	58.3900.133H	56,61
1737933	15.3900.840H	56,57,61
1781226	61.3902.100E	--
1788487	58.5710.001.099	21
1788972	58.5713.114.099	21
1796324	61.3482.149H	19,58
1805712	61.3480.149H	19,58
1805713	40.3485.412H	19,58
1805714	61.3481.149H	19,58
1805717	15.3480.840H	19,58
1812859	58.5713.114.099	21
1812862	61.5700.310.099	20
1812865	09.5700.002.099	20
1812867	58.5701.104.099	21
1816902	59.5595.131H	20
1816903	59.5595.132H	20
1816905	59.5595.134	--
1816906	59.5595.135	--
1816907	59.5595.136	--
1816912	59.5595.235H	20
1816913	59.5595.236	20
1816914	59.5595.331H	20
1816915	59.5595.332	20
1817860	61.5710.310.099	20
1818353	58.5710.001.099	21
1830338	61.5590.001.099	20,75
1830562	58.5700.001.099	21
1882111	12.5700.002.099	21
1882112	12.5700.004.099	21
1882113	12.5740.002.099	20
1882126	12.5700.001.099	21
1882127	12.5700.003.099	21
1940334	58.5700.003.002	21
1940335	58.5700.004.002	21
1940341	61.5740.001.099	20
1940342	19.5740.311.099	20
1949304	59.1005.001.099	21
1949305	59.1005.002.099	21
2248157	59.1027.001.099	22
2248158	59.1027.002.099	22
2248159	59.1005.011.099	23
2248160	12.1027.103.099	22
2248161	12.1027.104.099	22
2248164	12.1027.001.099	22
2248165	12.1027.002.099	22
2248166	12.1027.005.099	22
2248167	12.1027.006.099	22
2248168	12.1027.015.099	22
2248169	12.1027.016.099	22
2248172	12.1027.107.099	22
2248173	12.1027.108.099	22
2248174	12.1005.001.099	23
2248175	59.1027.003.099	22
2248176	59.1027.004.099	22
2248178	59.5590.013.099	23
2248179	59.5590.014.099	23
2248184	12.5590.009.099	23
2298758	12.1027.203.099	22
2298759	12.1027.204.099	22
2298826	12.1027.207.099	22
2298827	12.1027.208.099	22
2306586	61.1029.224.099	22
2306587	61.1024.224.099	22
2306590	19.1027.011.099	22
2306591	19.1027.012.099	22
2306592	19.1027.311.099	22
2306593	19.1027.312.099	22

OE		
Dennis Eagle		
1055967	59.1005.006.001	--
68152255	20.2710.650	39
<b>Eura Mobil</b>		
200070726	59.1018.001.099	72
200070727	59.1018.002.099	72
200070749	09.2910.005.099	72,75
<b>Eura Mobil</b>		
200070751	09.2910.002.099	72,75
200070813	12.1018.007.099	72
200070814	12.1018.009.001	72
200070817	12.1018.001.099	72
200070820	12.1018.002.099	72
200070822	12.1018.010.001	72
200083487	59.2760.005.001	--
200083496	59.2760.006.001	--
VI10-01-008B	11.3730.210H	18,23,38,68,73
VI10-02-001	51.3400.147H	26
VI10-02-004	09.3200.340	--
<b>Fendt/Valtra</b>		
F297810150010	40.2890.222H	66,68
F304810150030	40.1009.002.000	69
F743810150010	40.1009.001.000	69
G297810150030	51.3850.127H	66
G304810150020	51.1009.017.099	69
G816810150030	51.2890.117H	66
ACV0148490	51.1009.097.099	69
ACV0759270	40.1009.004.099	69
ACV0759280	40.1009.002.099	69
ACV0805960	51.1009.017.099	69
<b>Heuliez</b>		
50344917	15.2780.840	39,41
<b>HINO</b>		
879020002	51.3300.147H	--
879020008C	11.9060.100H	18,23
<b>HINO</b>		
879020009	59.3604.178H	--
879020009G	40.3605.203H	60
879020010	59.5524.820	--
879020011	51.5524.930H	22,57,61,67
879020017	51.3636.206	23,68
87902003	56.9065.110	18,23
87902007C	11.3730.210H	18,23,38,68,73
87902007G	15.3802.840H	23,68
87902008	61.9065.114H	18,23
87902008G	15.9060.870H	18,23
87930-0008A	59.2652.110H	27
<b>Hymer</b>		
0850034	40.3640.322H	28
1015718	55.2020.177H	--
1287034	59.2761.302	--
1289691	20.2480.222	--
1299452	20.2700.200H	38,73
1316712	58.2704.065	--
2668945	11.2780.920	39
2673925	20.2710.620	38,39,77
2674190	51.3200.137H	--
2698041	40.3640.322H	28
2698081	09.3200.360	--
2698087	56.1471.117	--
2725823	11.3730.210H	18,23,38,68,73
2726750	59.2761.112	--
2771210	40.2500.322	--
2943025	20.2760.140	--
2943027	20.2760.150	--
38305	56.1471.117	--
383183	51.2510.127H	28
VI10-02-005	40.3640.322H	28
<b>Irisbus</b>		
42545989	15.2712.114	38,73
42545990	11.3730.210H	18,23,38,68,73
42548988	15.2711.114	38,73
5006232165	58.2704.088	79
5006232166	58.2704.089	--
5006232482	51.3732.326	38,73
71101611	59.2710.411	--
71101611/612 SO	20.2710.200H	38,73
71101612	59.2710.412	--
<b>Irisbus</b>		
71701878	09.3200.220	76
<b>Iveco</b>		
2996670	56.4620.247H	--
2996671	56.4620.267H	--
42309921	51.1523.111H	--
42545983	59.2710.412	--
42545985	20.2480.217H	38,50,73,77
42556227	11.3730.210H	18,23,38,68,73
42556228	15.3731.470H	18,38,73
500086749	192.790.012.099	25
500086750	192.790.011.099	25

OE		
Iveco		
500086753	192.790.031.099	25
500086754	192.790.032.099	25
5001851891	11.2810.200H	50
5001851897	08.2810.124	--
5001852000	20.2810.310	--
5001861684	40.2816.403	--
5010403393	09.2810.400	--
5010404852	59.2810.113H	50
5010411090	59.2810.111H	50
5010482937	59.2810.211H	--
5010482938	59.2810.213H	--
503449902	11.2770.920	40
503449909	15.2771.840	40
503651179	11.2770.920	40
504132249	56.4620.247H	--
504150526	59.1008.005.099	24
504150527	59.1008.006.099	24
504150538	59.1008.011.099	24
504150539	59.1008.012.099	24
504150551	59.1008.017.099	24
504150552	59.1008.018.099	24
504168235	56.1008.001.099	24
504168236	56.1008.002.099	24
504168244	11.1008.001.099	24
504197878	19.1008.041.099	24
504197879	19.1008.311.099	24
504224428	55.1008.002.099	25
504369910	59.1008.005.099	24
504369961	59.1008.006.099	24
504369979	59.1008.017.099	24
504369995	59.1008.018.099	24
504370048	59.1008.011.099	24
504370055	59.1008.012.099	24
5801334610	59.1008.006.099	24
5801334614	59.1008.005.099	24
5801336285	59.1008.011.099	24
5801336298	59.1008.012.099	24
5801341206	59.1008.017.099	24
5801341207	59.1008.018.099	24
5801404796	59.2770.211.099	40
5801404799	59.2762.101	38
5802498968	112.790.001.099	25
5802498969	112.790.002.099	25
93190970	15.4601.164H	--
93190971	20.4601.100H	--
93190974	20.4621.100H	--
93190976	15.4611.164H	--
93190977	20.4611.100H	--
98472977	51.4601.120H	--
98472979	51.4601.130H	--
98472983	51.4612.130H	--
<b>Johns Deere</b>		
AKK34593	51.1009.113.099	69
AL158964	51.3850.127H	66
AL203151	15.5701.840H	20
AL225823	19.1036.007.099	71
AL225824	19.1036.008.099	71
AL232743	51.1036.009.099	71
AL232744	51.1036.010.099	71
AZ100260	56.2650.121H	27
AZ100261	11.1523.010	--
AZ104094	51.3636.205	--
AZ104180	51.3635.205	--
AZ65395	40.3300.318	--
R566924	11.1036.011.099	71
<b>Kässbohrer</b>		
8.688.000.244.0	40.2520.422H	60
8.688.000.256.0	09.3200.320H	76
8.688.032.13.0	10.6321.100	26,27
8.688.100.253.0	40.2890.422H	66,68
8.688.105.262.0	09.3200.340	--
8.688.105.264.0	11.3730.210H	18,23,38,68,73
8.688.117.000.0	51.1009.250.001	--
8.688.120.000.0	51.1009.001.099	69
8.688.128.000.0	59.1017.003.099	70
8.688.129.000.0	59.1017.004.099	70
8.748.026.000.0	55.2462.117	--
8.748.036.000.0	56.1562.110	--
814.67.10.100.1	51.2520.147H	60
86881000000	51.3850.247	66
86881050000	51.3635.206	23,68
86881052630	15.3802.840H	23,68
86881060000	51.3636.206	23,68
99707305609	40.2660.404H	27
<b>KFB</b>		
Y07001023	51.3850.147H	66
<b>Komatsu</b>		
21D-54-41710	51.1009.017.099	69
42154H3380	51.1009.025.099	69
42154H3480	51.1009.017.099	69
<b>Kramer</b>		
1000379630	51.1009.022.099	69
1000379641	51.1009.122.099	69

# Vergleichsliste nach OE-Nummern Cross-reference-table

OE		
<b>Kramer</b>		
1000386860	51.1009.017.099	69
1000390196	51.1009.149.099	69
1000396281	51.1009.097.099	69
<b>Krone</b>		
270011780	51.3635.201	23,68
<b>Liebherr</b>		
10218823	55.3000.108H	--
10285254	55.2020.177H	--
10287949	51.3636.206	23,68
10287953	51.3635.206	23,68
10300676	56.2600.127H	26
10303351	51.3640.137H	28
10334227	11.3730.210H	18,23,38,68,73
10342167	09.2070.101H	26,28,42,60,68,76
10470601	15.3802.840H	23,68
10472808	58.2600.010H	--
10472809	56.2660.147H	27
10675116	40.2635.204F	--
10877369 / 5707 57877	51.2520.127H	60
11008727	51.3640.128.001	--
11066581	58.2704.075.001	--
11068341	51.1009.017.099	69
11181691	51.1009.049.001	--
11182172	09.2070.101H	26,28,42,60,68,76
1118692	09.2000.301H	26,27,66,69,76
11657850	61.3480.149H	19,58
11657851	58.1016.001.099	78
11657852	58.1016.002.099	78
11657853	58.1016.005.099	78
11657854	58.1016.006.099	78
11657855	20.1016.004.000	78
11830241	11.1200.502.099	--
11830530	59.1005.004.001	--
11931048	20.2710.630	--
12218370	59.1005.004.001	--
12230063	40.1009.001.000	69
12230064	40.1009.003.099	--
12254474	09.3200.320H	76
12269787	58.1016.004.099	78
571070008	09.2070.101H	26,28,42,60,68,76
571229808	40.2520.422H	60
571572108	09.3200.340	--
571572208	09.3200.220	76
571757008	08.3492.324.099	--
591055977	59.2640.110H	--
591056608	51.2520.147H	60
591059377	56.2660.127H	27
591060808	56.2640.127H	--
591061008	56.2661.147	--
591069208	09.3200.440	--
591070908	56.2630.127	--
591077608	58.2704.042	--
591080008	58.2486.507	--
7004956	51.1524.119H	68
7005028	51.3640.127	--
7017444	56.2660.127H	27
7021442	51.3640.147H	28
7022092	51.2461.117H	--
7616670	51.1523.121H	--
7619627	55.2021.177	--
7621216	20.2480.210H	77
7621717	51.2530.128H	--
<b>Lindner</b>		
3006104	51.3495.112H	63
3006232	56.3492.110H	51,63
3006233	56.3491.110H	51,63
3009960	51.1009.043.001	--
3009961	58.1017.011.099	70
3009999	58.1017.012.099	70
3010115	51.1009.001.099	69
3010188	51.1009.081.099	69
3010662	51.1009.017.099	69
3010850	51.1009.021.099	69
3010851	51.1009.022.099	69
3010852	51.1009.121.099	69
3010853	51.1009.122.099	69
3022116	40.1009.001.000	69
3205677	40.1009.004.099	69
3205678	40.1009.002.099	69
3207388	40.1009.002.000	69
3207415	11.1009.004.000	--
<b>MAN</b>		
11075175	59.2762.101	38
16100772027	09.3400.420	26,66,76
33.25203-6001	08.2910.001.002	40,75
33.25404-6190	09.2770.211	--
33.63730-6003	51.3635.206	23,68
33.63731-6002	58.2705.002	--
336373060001	51.3850.267	66
36.25404-6033	09.1041.002.099	41
36.63700-6017	59.1042.001.099	41
36.63700-6018	59.1041.001.099	41
36.63700-6019	59.1042.003.099	41
36.63700-6020	59.1042.004.099	41

OE		
<b>MAN</b>		
36.63700-6022	59.1042.002.099	41
36.63730-6013	56.1523.117H	--
36.63730-6024	59.2910.500.001	--
36.63731-6000	20.2710.620	38,39,77
36.63731-6001	20.2710.630	--
36.63731-6012	20.1042.002.099	41
36.63731-6013	20.1042.003.099	41
36.63732-0000	11.2770.102	40
36.63732-0001	11.2770.302	40
36.63732-0002	11.2770.202	40
36.63732-0003	11.2770.402	40
36.63732-0004	11.2770.620	--
36.63732-0006	11.2780.920	39
36.63732-0024	61.2910.009.002	--
36.63732-0044	36.63732-0044	--
36.63732-6000	61.2770.900.099	40
36.63733-0009	19.2910.002.099	41,75
36.92611-0002	11.2770.040	--
65.63733-0002	19.1013.011.099	37
65.63733-0006	19.1013.013.099	37
65.63733-0014	19.1013.013.099	37
65.63733-0015	19.1013.011.099	37
81.25404-6247	09.3200.310H	--
81.25406-6252	09.3200.360	--
81.25432-0149	09.2070.101H	26,28,42,60,68,76
81.25505-6247	08.2770.001.000	40
81.25525-0232	08.3200.233H	39,40,72,75,76
81.62410-0107	20.5800.710H	35
81.62410-0108	20.5800.720H	35
81.62410-0109	20.5800.750H	35
81.62730-6221	51.3410.147H	26
81.633732-0089	61.2772.100	40
81.6370-0032	40.3640.422H	26,28
81.63730	51.3922.222H	32
81.63730 - 6127/-6167	51.2510.127H	28
81.63730-0032	40.3640.422H	26,28
81.63730-0058	08.3400.324	--
81.63730-0067	15.3731.074H	30
81.63730-0082	61.2770.110	--
81.63730-0083	61.2770.210	40
81.63730-0066	15.3731.070H	30
81.63730-6001	51.3640.147H	28
81.63730-6003	40.3640.422H	26,28
81.63730-6016	51.3400.147H	26
81.63730-6094	51.2460.218H	--
81.63730-6108	51.3640.127H	28
81.63730-6126	51.3640.127H	28
81.63730-6128	51.2510.147H	28
81.63730-6138	56.1562.110	--
81.63730-6147	51.3640.127H	28
81.63730-6148	51.3640.127H	28
81.63730-6149	51.3640.127H	28
81.63730-6151	51.3640.147H	28
81.63730-6193	51.3200.147H	26
81.63730-6194	51.3640.127H	28
81.637306202	40.3640.422H	26,28
81.63730-6202	40.3640.422H	26,28
81.63730-6206	56.2600.127H	26
81.63730-6220	51.3410.127H	26
81.63730-6221	51.3410.127H	26
81.63730-6222	56.2660.127H	27
81.63730-6223	56.2660.147H	27
81.63730-6224	56.2650.121H	27
81.63730-6233	51.3410.127H	26
81.63730-6234	51.3410.147H	26
81.63730-6235	56.2660.127H	27
81.63730-6236	56.2660.147H	27
81.63730-6237	59.2652.110H	27
81.63730-6294	59.3652.128H	27
81.63730-6295	59.3652.147H	--
81.63730-6296	59.3652.167H	--
81.63730-6299	56.2660.147H	27
81.63730-6303	51.3736.121H	30
81.63730-6305	51.3736.126H	30
81.63730-6306	56.3860.112H	30
81.63730-6307	56.3860.114H	30
81.63730-6308	56.3862.116H	30
81.63730-6314	51.3735.121H	30
81.63730-6315	51.3735.124H	30
81.63730-6316	51.3735.126H	30
81.63730-6317	56.3861.116H	30
81.63730-6328	56.3862.116H	30
81.63730-6331	51.3735.121H	30
81.63730-6332	51.3736.121H	30
81.63730-6345	51.3921.222H	32
81.63730-6347	51.3922.222H	32
81.63730-6350	56.3932.222H	--
81.63730-6351	56.3931.222H	--
81.63730-6361	51.3735.124H	30
81.63730-6362	51.3736.124H	30
81.63730-6363	51.3735.126H	30
81.63730-6364	51.3736.126H	30
81.63730-6365	51.3735.124H	30
81.63730-6366	51.3736.124H	30
81.63730-6367	51.3735.126H	30
81.63730-6368	51.3736.126H	30
81.63730-6369	51.3922.232H	--

OE		
<b>MAN</b>		
81.63730-6373	08.3492.324.099	--
81.63730-6375	51.3731.326	38,73
81.63730-6394	51.3924.222H	--
81.63730-6395	51.3921.222H	32
81.63730-6398	51.3923.222H	32
81.63730-6401	51.3922.232H	--
81.63730-6409	56.3931.222H	--
81.63730-6410	56.3932.222H	--
81.63730-6420	51.3412.120H	26
81.63730-6421	56.2662.120H	27
81.63730-6430	51.3921.222H	32
81.63730-6431	51.3924.222H	--
81.63730-6432	51.3922.222H	32
81.63730-6433	51.3923.222H	32
81.63730-6434	51.3922.232H	--
81.63730-6443	56.3931.222H	--
81.63730-6444	56.3932.222H	--
81.63730-6480	51.3921.223H	33
81.63730-6481	51.3922.223H	33
81.63730-6482	51.3921.224H	33
81.63730-6483	51.3922.224H	33
81.63730-6484	51.3924.223H	--
81.63730-6485	51.3923.223D	33
81.63730-6486	51.3924.224H	33
81.63730-6487	51.3922.222H	33
81.63730-6492	51.3922.233H	--
81.63730-6510	56.3931.343H	33
81.63730-6511	56.3932.343H	33
81.63730-6512	56.3931.323H	33
81.63730-6513	56.3932.323H	33
81.63730-6529	59.5800.101H	35
81.63730-6531	59.5800.201H	35
81.63730-6533	59.5800.121H	35
81.63730-6534	59.5800.221H	35
81.63730-6549	59.5800.122H	35
81.63730-6550	59.5800.222H	35
81.63730-6551	59.5800.422H	35
81.63730-6552	59.5800.322H	35
81.63730-6553	59.5800.223H	35
81.63730-6560	59.5800.102H	35
81.63730-6561	59.5800.202H	35
81.63730-6562	59.5800.402H	35
81.63730-6563	59.5800.302H	35
81.63730-6564	59.5800.203H	35
81.63730-6573	56.5790.004.099	29,32,45,47
81.63730-6574	56.5790.003.099	29,32
81.63730-6578	56.5790.002.099	3

Cross-reference-table Vergleichsliste nach OE-Nummern

OE		
MAN		
81.63730-6879	59.1024.022.099	36
81.63730-6881	56.1020.015.099	37
81.63731-0111	13.400.300	--
81.63731-0157	20.2600.111H	--
81.63731-0158	20.2600.112H	--
81.63731-0286	11.3920.300H	32
81.63731-0298	11.3400.510	--
81.63731-0302	20.2710.500	--
81.63731-0309	11.3921.400	33,34
81.63731-0356	11.5800.100H	35
81.63731-0366	11.3921.400	33,34
81.63731-0372	61.2770.111	--
81.63731-0373	61.2770.211	40
81.63731-0380	11.5800.200H	35
81.63731-0397	11.5800.100H	35
81.63731-6468	20.2710.121	73
81.63731-6469	20.2710.111H	73
81.63731-6470	20.2480.222	--
81.63731-6471	20.2480.221	--
81.63731-6474	20.2700.240	--
81.63731-6475	20.2700.230	--
81.63731-6477	58.2710.101	--
81.63731-6478	20.2480.223	77
81.63731-6539	20.2710.132D	--
81.63731-6540	20.2710.142D	--
81.63731-6638	58.5800.101H	35
81.63731-6639	58.5800.102H	35
81.63731-664	58.5800.202H	35
81.63731-6640	58.5800.201H	35
81.63732-0019	14.2530.100	--
81.63732-0044	11.3800.300H	31
81.63732-0045	11.3810.300H	--
81.63732-0046	51.3736.124H	30
81.63732-0047	51.3736.126H	30
81.63732-0048	56.3862.116H	30
81.63732-0049	56.3861.116H	30
81.63732-0050	56.3860.114H	30
81.63732-0051	51.3736.126H	30
81.63732-0054	11.3921.110H	32,33
81.63732-0056	11.3931.120H	33
81.63732-0057	11.3931.110H	33
81.63732-0058	11.3730.210H	18,23,38,68,73
81.63732-0059	11.3921.120H	32,33
81.63732-0061	11.3921.110H	33
81.63732-0062	11.3931.120H	33
81.63732-0063	11.3921.120H	32,33
81.63732-0065	11.3931.110H	33
81.63732-0066	11.3931.120H	33
81.63732-0073	20.5800.410H	35
81.63732-0074	20.5800.420H	35
81.63732-0075	20.5800.610H	35
81.63732-0076	20.5800.620H	35
81.63732-0078	11.3810.300H	--
81.63732-0087	11.2770.920	40
81.63732-0088	11.2780.910	39
81.63732-0090	20.5800.750H	35
81.63732-0091	13.5800.100H	35
81.63732-0094	12.3920.001.099	34
81.63732-0095	12.3920.002.099	34
81.63732-0096	12.3930.001.099	34
81.63732-0097	12.3930.002.099	34
81.63732-0098	11.2780.520	--
81.63732-0106	12.1020.003.099	37
81.63732-0110	13.1024.002.099	36
81.63732-0111	13.1024.001.099	36
81.63732-0112	12.1024.012.099	36
81.63732-0113	12.1024.011.099	36
81.63732-0114	12.1024.010.099	36
81.63732-0115	12.1024.009.099	36
81.63732-0125	13.1024.003.099	36
81.63733.0032	40.2510.222H	28
81.63733-0025	40.3640.222H	26,28
81.63733-0030	40.3640.222H	26,28
81.63733-0036	40.3200.422H	26
81.63733-0042	40.2605.204H	26
81.63733-0060	40.3640.222H	26,28
81.63733-0061	40.2665.204H	27
81.63733-0064	40.3640.422H	26,28
81.63733-0066	15.3731.070H	30
81.63733-0067	15.3731.074H	30
81.63733-0075	15.3731.470H	18,38,73
81.63733-0082	15.3921.870H	32
81.63733-0083	15.3922.870H	--
81.63733-0085	15.3931.870H	32
81.63733-0097	15.3811.870H	31
81.63733-0098	15.3811.870H	31
81.63733-0099	15.3946.670F	27
81.63733-0101	40.5725.212H	29
81.63733-0103	40.5725.412H	29,62
81.63733-0104	40.5735.203H	29
81.63733-0106	40.5735.403H	29,62
81.63733-0110	15.2771.840	40
81.63733-0111	15.2771.870	40
81.63733-0112	15.2780.870	39
81.63733-0113	15.2780.840	39,41,75
81.63733-0114	15.2561.640	--
81.63733-0115	15.2561.600	--

OE		
MAN		
81.637330-6003	40.3640.422H	26,28
81.63733-604	40.3640.422H	26,28
81.63733-6003	40.3640.422H	26,28
81.63733-6007	40.2660.404H	27
81.63733-6029	15.3731.470H	18,38,73
81.63733-6033	15.3921.870H	32
81.63733-6034	15.3922.870H	32
81.63733-6037	15.3931.870H	--
81.63733-6049	15.3920.840H	33
81.63733-6057	15.3932.870H	33
81.63733-6071	15.5801.840H	35
81.63733-6072	15.5811.872H	35
81.63733-6073	15.5811.871H	35
81.63733-6074	15.5791.470H	29,32,45,47
81.63733-6078	15.5791.570.099	29,32,34,35
81.63733-6079	19.3920.011.099	34
81.63733-6080	19.3930.311.099	34
81.63733-6083	19.1024.011.099	36
81.63733-6084	19.1024.012.099	36
81.63733-6085	19.1024.311.099	36
81.63733-6086	19.1024.312.099	36
81.63733-6087	19.1020.213.099	37
81.63733-6088	19.1020.613.099	37
81.63734-6001	08.5752.024.099	22,39,40,56,57,61
81.63734-6006	08.1024.124.099	41
81637306374	51.3732.326	38,73
81637306375	51.3731.326	38,73
81637306390	51.3732.326	38,73
81637310289	20.2710.200H	38,73
81637316470	20.2480.217H	38,50,73,77
81637320058	11.3730.210H	18,23,38,68,73
81637330113	15.2780.840	39,41,75
81637336027	15.2711.114	38,73
81637336028	15.2712.114	38,73
81637336029 /		
81637330075	15.3731.470H	18,38,73
82.25451-6399	09.2500.300	--
82.63730-6015	51.3801.148H	31
82.63730-6016	51.3802.148H	31
82.63730-6017	51.3801.168H	31
82.63730-6018	51.3802.168H	31
82.63730-6021	56.3812.128H	31
82.63730-6022	56.3812.128H	31
82.63730-6023	56.3812.148H	31
82.63730-6024	56.3812.148H	31
82.63730-6025	56.3811.168H	31
82.63730-6026	56.3812.168H	31
82.63730-6033	59.3652.128H	27
82.63730-6034	59.3652.148H	27
82.63730-6035	59.3652.168H	27
83.25402-6010	09.2000.301H	26,27,66,69,76
83.63700-6501	59.2712.114	38
83.63700-6502	59.2712.111	38
83.63700-6510	59.2780.140.001	39
83.63700-6511	59.2780.150.001	39
83.63700-6530	59.1041.003.099	41
83.63731-6507	20.2480.216H	38,50,73,77
83637316507	20.2480.216H	38,50,73,77
85.200009601	40.3640.422H	26,28
85.20000-9601	40.3640.422H	26,28
85.63730-6015	51.3400.147H	26
85.63730-6030	51.5720.120H	29
85.63730-6033	51.5720.140H	29
85.63730-6035	51.5721.160H	29
85.63730-6036	51.5722.160H	29
85.63730-6037	56.5730.120H	29
85.63730-6039	56.5730.140H	29
85.63731-6101	58.3405.261Y	--
85.63731-6102	58.3406.250Y	--
85.63731-6104	58.3406.252Y	--
85.63731-6106	58.3406.254Y	--
85.63731-6107	58.3405.262H	--
85.63731-6108	58.3406.251H	--
85.63731-6109	58.3405.264Y	--
85.63731-6126	58.3402.112Y	--
88.25426-6837	09.2770.210	40
88.25505-0024	09.3200.420H	26,69,71
88.63700-6059	59.2780.120.099	39
88.63700-6060	59.2771.210.099	40
88.63700-6062	59.2770.211.099	40
88.63700-6063	59.2780.110	--
88.63700-6064	59.2770.110	--
88.63730-6041	51.3400.147H	26
88.63730-6077	55.2561.010	--
88.63730-6078	55.2561.110	--
88.63731-6131	20.2780.630	--
A0048208342	08.3000.324	--
AP138274C-2	11.2780.920	39
N1.01103-5783	58.2601.010	--
81.63732-0124	13.1024.004.099	36
Marco Polo		
09379861018	20.2710.121	73
17294281	20.2710.200H	38,73
172942890	51.3731.326	38,73
Mauser		
6-200.26.185	51.1036.025.099	71

OE		
Mercedes		
0018210029	10.6221.100	28,66,68
0001505533	09.2070.101H	26,28,42,60,68,76
0004400015	08.5890.300.099	53,65
0004400115	08.5890.301.099	53,65
0004400515	08.5890.004.099	--
0004401501	08.5890.003.099	--
0008100211	20.2810.110H	--
0008100279	61.3752.147H	43,50
0008100379	61.3752.167H	43,50
0008100416	51.2540.120H	42
0008100616	51.2540.130H	42
0008100879	56.3960.148H	45,47
0008101479	51.5750.004.099	44
0008101579	51.5750.002.099	44
0008101679	51.5770.001.099	44
0008101779	51.5750.003.099	44
0008101879	51.5750.001.099	44
0008102016	51.2540.130H	42
0008102079	51.5750.001.099	44
0008102179	51.5750.002.099	44
0008102279	51.5750.003.099	44
0008102316	51.2530.140H	42
0008102379	51.5750.004.099	44
0008102479	51.5770.001.099	44
0008102716	51.2530.120H	42
0008103613	61.3000.001.001	67
0008103713	61.3000.002.001	67
0008104816	51.2540.120H	42
0008106216	51.2530.120H	42
0008109516	61.3782.147H	46
0008109616	61.3772.147H	43,46
0008110239	61.2530.110H	42
0008110361	20.3750.710.099	43
0008110461	20.3750.720.099	43
0008111122	13.5890.210.199	53,55,65
0008111233	51.2530.120H	42
0008111307	61.3780.100H	43,45,46,47,50
0008111807	20.5750.710.099	44
0008111907	20.5750.720.099	44
0008111933	40.2540.222H	42
0008112007	61.5750.120H	44
0008112033	40.2530.222H	42
0008112133	40.2530.222H	42
0008113333	40.2530.222H	42
0008113533	40.2540.222H	42
0008114033	15.5891.722.099	53,55,65
0008116433	40.2530.222H	42
0008118433	40.3680.222H	--
0008130436	14.5890.100.099	53,55,65
0008130536	14.5890.200.099	53,55,65
0008201277	08.5892.105.099	53,55,65
0008202713	09.5750.001.099	44
0008202813	09.5750.020.099	44
0008210129	10.3681.400	--
0008211229	10.3681.400	--
0018104414	58.3781.100H	46
0018104514	58.3781.200H	46
0018106016	15.2711.114	38,73
0018106116	15.2712.114	38,73
0018109016	61.3783.147H	46
0018109116	61.3783.167H	46
0018109216	61.3773.147H	43,46,50

# Vergleichsliste nach OE-Nummern Cross-reference-table

OE		
Mercedes		
0028110033	15.5770.870H	44
0028110333	15.3791.470H	--
0028110433	15.3780.840H	46
0028111533	15.5891.741H	53,65
0028111633	15.5891.742H	53,65
0028111933	15.5891.611H	53,65
0028112033	15.5891.612H	53,65
0028112233	15.5791.470H	29,32,45,47
0028113333	19.1012.002.099	48
0028113433	19.1012.003.099	48
0028113733	19.1012.000.099	48
0028113833	19.1012.001.099	48
0028113933	15.5891.721.099	53,55,65
0028114633	19.5750.011.099	44
0028114733	19.5770.311.099	44
0028115233	19.5890.011.099	53,55,65
0028115333	19.5890.012.099	53,55,65
0028115633	19.5891.011.099	53,65
0028115733	19.5891.012.099	53,65
0028116333	15.6000.001.099	48
0028116433	15.6000.002.099	48
0028116533	15.6000.003.099	48
0028116633	15.6000.004.099	48
2818107116	51.2530.120H	42
3018102116	51.2530.140H	42
3148101316	51.2540.120H	42
3148101916	51.2540.130H	42
3148102016	51.2540.140H	42
3148102616	51.2530.140H	42
3568100611	20.2480.213	73,77
3600100512654	58.2704.048	79
3818102516	51.2530.120H	42
3818102616	51.2530.140H	42
3818107116	51.2530.120H	42
3818107316	51.2530.140H	42
6118100116	51.3490.110H	51
6228100116	59.3980.141	50
6288103016	59.3980.121	50
6288103116	59.3980.122	50
6288103316	59.3980.111	50
6288103416	59.3980.112	50
6288103616	59.3980.131	--
6288103716	59.3980.132	50
6298110033	15.3951.174	50
6298110133	15.3951.114	50
6298110233	15.3952.174	50
6338100216	59.3980.142	50
6418104216	51.3680.147H	--
6418104416	51.3680.167H	--
6418106816	51.3680.147H	--
6638100816	51.2530.120H	42
6718100095	20.2710.620	38,39,77
6718100716	59.3980.011H	50
6718100916	59.3980.021H	50
6718101316	59.3980.022H	50
6718101111	20.2480.210H	77
6738100816	51.2530.120H	42
6738103916	51.2540.120H	42
6738104016	51.2530.120H	42
6738104116	51.2540.140H	42
6738104216	51.2530.140H	42
86880001840	51.3640.127	--
86880320130	10.6321.100	26,27
86880410010	40.2500.222H	60
86880410290	10.6121.100	26,28
86880751690	08.2810.124	--
86880902140	11.2810.200H	50
86880902250	20.2810.310	--
87480181000	51.2510.127H	28
89199311514	08.3200.500	--
89199718444	40.2540.422H	42
8919978658	40.2540.422H	42
9018100116	51.3490.110H	51
9018100216	51.3490.120H	51
9018100916	51.3490.112H	51
9018101016	51.3490.122H	51
9018101093	56.3491.110H	51,63
9018101193	56.3492.110H	51,63
9018102516	59.3491.110H	51
9018102616	59.3491.120H	51
9018103716	59.3492.110H	51
9018103816	59.3492.120H	51
9018105716	51.3490.112H	51
9018105816	59.3491.110H	51
9018106116	59.3492.110H	51
9018106416	51.3490.120H	51
9018106616	51.3490.122H	51
9018106716	59.3491.120H	51
9018107016	59.3492.120H	51
9068101893	51.5891.111.199	52,64
9068101993	51.5891.211.199	52,64
9068102093	51.5891.411.199	52,64
9068102293	51.5892.111.199	52,64
9068102393	51.5892.211.199	52,64
9068102493	51.5892.411.199	52,64
9068102593	51.5892.311.199	52,64
9068102693	51.5893.111.199	52,64

OE		
Mercedes		
9068102793	51.5893.211.199	52,64
9068103093	51.5891.112.199	--
9068103193	51.5891.212.199	--
9068103293	51.5891.412.199	--
9068103393	51.5891.312.199	--
9068103493	51.5892.112.199	--
9068103593	51.5892.212.199	--
9068103693	51.5892.412.199	--
9068103793	51.5892.312.199	--
9068103893	51.5893.112.199	--
9068103993	51.5893.212.199	--
9068104293	51.5891.114.199	--
9068104393	51.5891.214.199	--
9068104493	51.5891.414.199	--
9068104593	51.5891.314.199	--
9068104816	51.5891.111.199	52,64
9068104916	51.5891.211.199	52,64
9068105016	51.5891.411.199	52,64
9068105116	51.5891.311.199	52,64
9068105216	51.5892.111.199	52,64
9068105316	51.5892.211.199	52,64
9068105416	51.5892.411.199	52,64
9068105516	51.5892.311.199	52,64
9068105616	51.5893.111.199	52,64
9068105716	51.5893.211.199	52,64
9068106016	51.5891.113.199	52,64
9068106116	51.5891.213.199	52,64
9068106216	51.5891.413.199	52,64
9068106316	51.5891.313.199	52,64
9068106393	51.5894.410.199	52,64
9068106416	51.5892.113.199	52,64
9068106493	51.5894.310.199	52
9068106516	51.5892.213.199	52,64
9068106593	51.5894.112.199	--
9068106616	51.5892.413.199	52,64
9068106693	51.5894.212.199	--
9068106716	51.5892.313.199	52,64
9068106816	51.5893.113.199	52,64
9068106916	51.5893.213.199	52,64
9068107993	51.5895.412.199	--
9068108093	51.5895.312.199	--
9408105516	59.3964.210H	45
9418101016	59.3792.127H	--
9418102116	59.3792.127H	--
9418110007	20.3780.700H	46
9438104716	59.3965.210H	47
9738100314	58.3752.100	43
9738100414	58.3752.200	43
9738107316	59.3962.210H	45
0001590268	09.3200.320H	76
0008100102	51.5720.001.099	--
0008100211	20.2810.110H	46
0008100412	61.2703.110	79
0008100512	61.2703.120	79
0008100617	51.2500.127H	60
0008101613	11.3001.100	--
0008103716	51.2520.147H	60
0008105316	51.3200.147H	26
0008108316	51.3410.147H	26
0008110135	14.2530.100	--
0008110818	11.3491.200	--
0008110839	11.3491.300	--
0008114730	51.3209.197	--
0008115130	51.3490.282E	--
0008115330	51.3490.272E	--
0008115530	51.3490.182E	--
0008115730	51.3491.102.099	--
000811730 /		--
0008115630	51.3491.101E	--
0008117733	40.3200.422H	26
0008119133	40.3665.118F	--
0008205198	10.6221.100	28,66,68
0008205198	10.6221.100	28,66,68
0008210929	10.6211.114	--
0018106116	15.2712.114	38,73
0018107216	51.3731.326	38,73
0018111433	40.2660.404H	27
0018210029	10.6221.100	28,66,68
0018271104	09.2810.220	--
0028104216	51.3770.001.002	--
0028106016	56.1004.001.099	45,47,48
0048204715	09.3200.360	--
3568100611	20.2480.213	73,77
3578110471	11.3730.210H	18,23,38,68,73
3818107216	51.2530.130H	--
4068105216	51.1522.211H	--
4168100416	51.1523.111H	--
6298100416	59.3951.300	--
6298110133	15.3951.114	50
9108100300	59.1039.125.099	54
9108100400	59.1039.225.099	54
9108100401	59.1039.525.099	55
9108100500	59.1039.175.099	54
9108100501	59.1039.625.099	55
9108100600	59.1039.275.099	54
9108100601	59.1039.575.099	55
9108100701	59.1039.675.099	55

OE		
Mercedes		
9108100801	59.1039.501.099	55
9108100901	59.1039.601.099	55
9108101001	59.1039.551.099	55
9108101100	59.1039.104.099	54
9108101101	59.1039.651.099	55
9108101200	59.1039.204.099	54
9108101300	59.1039.154.099	--
9108101400	59.1039.254.099	54
9108101601	59.1039.701.099	55
9108101701	59.1039.801.099	55
9108101801	59.1039.751.099	55
9108101900	59.1039.105.099	54
9108101901	59.1039.851.099	55
9108102000	59.1039.205.099	54
9108102100	59.1039.155.099	54
9108102200	59.1039.255.099	54
9108107001	59.1039.558.099	55
9108107101	59.1039.658.099	55
9108108901	59.1039.101.099	54
9108109001	59.1039.201.099	54
9108109101	59.1039.151.099	54
9108109201	59.1039.251.099	54
9108109501	59.1039.158.099	54
9108109601	59.1039.258.099	54
9108112400	19.1039.412.099	54
9108112500	19.1039.411.099	54
9108112600	19.1039.012.099	54
9108112700	19.1039.011.099	54
9108112800	19.1039.812.099	54
9108112900	19.1039.811.099	54
9108113600	19.1039.312.099	54
9108113700	19.1039.311.099	54
9108113800	11.1039.012.099	54
9108113900	11.1039.011.099	54
9108114000	13.1039.002.099	54
9108114100	13.1039.001.099	54
9108114400	11.1039.002.099	54
9108114500	11.1039.001.099	54
9108250400	61.1039.002.099	54
9109064600	08.1039.002.099	54
9109064700	08.1039.001.099	54
9109065600	08.1039.011.099	54
9578110033	40.3605.204F	60
66560398	56.3492.110H	51,63
<b>Miller</b>		
545541	51.1009.009.001	--
<b>Moreto</b>		
205804	59.1018.007.099	72
205805	59.1018.008.099	72
205815	12.1018.001.099	72
205816	12.1018.002.099	72
205820	12.1018.005.099	72
205822	12.1018.009.001	72
205824	12.1018.010.001	72
205825	09.2910.005.099	72,75
205826	09.2910.002.099	72,75
<b>Niesmann + Bischoff</b>		
0866048	59.3601.128H	60
10222	59.3601.128H	60
12667	59.2761.302	--
121082	15.2780.841F	39,72,75
22922	59.1018.007.099	72
25032	19.1018.311.099	72
28852	12.1018.010.001	72
288523	12.1018.009.001	72
8002710	59.2761.302	--
8017159	59.2761.112	--
8020384-00	59.2780.230	39
8020385	59.2780.130	39
8034580	15.2780.841F	39,72,75
8034581 / 21082	15.2780.871F	39
8042965 / 23144	09.2910.005.099	72,75
8042972	59.101	

# Cross-reference-table Vergleichsliste nach OE-Nummern

OE		
<b>Plaxton</b>		
175202B-7	12.1018.001.099	72
175202B-8	12.1018.010.001	72
175202B-9	12.1018.009.001	72
198806C	59.2780.120.099	39
68152256	61.2910.001.001	75
76802907	09.2910.002.099	72,75
AA01976	59.2710.401H	73
AA01977	59.2710.406	73
AA01978	20.2710.200H	38,73
AA01980	20.2480.213	73,77
AA-01980	20.2480.213	73,77
AA-01982	20.2710.111H	73
AA-01983	20.2710.121	73
AP064924B	59.2704.122	--
AP064924B-3	20.2700.161	--
AP064924B-4	20.2480.211H	77
AP083895B-1	15.2712.113F	73
AP105367C-3	15.3802.840H	23,68
AP107424C-10	20.2480.217H	38,50,73,77
AP107424C-4	51.3636.206	23,68
AP119170C-10	11.2910.003.000	75
AP119170C-100	59.2910.003.001	74
AP119170C-100	59.2910.003.001	74
AP119170C-11	11.2910.006.000	75
AP119170C-12	11.2910.008.000	75
AP119170C-13	11.2910.002.000	75
AP119170C-14	61.2910.011.002	--
AP119170C-15	11.2910.007.000	75
AP119170C-16	61.2910.012.002	--
AP119170C-17	11.2910.011.002	75
AP119170C-18	11.2910.012.002	75
AP119170C-2	59.2910.010.001	74
AP119170C-5	61.2910.009.002	--
AP119170C-6	61.2910.019.002	--
AP119170C-7	19.2910.001.099	41,75
AP119170C-9	11.2910.001.000	75
AP138271C-1	11.2780.510	--
AP138271C-2	11.2780.910	39
AP138271C-3	15.2780.870	39
AP138274C	59.2780.180.001	39
AP138274C-1	11.2780.520	--
AP140857C-1	59.2910.009.001	74
AP140857C-3	61.2910.005.001	75
AP140857C-4	61.2910.006.001	75
APAA-01976-4	11.3730.210H	18,23,38,68,73
APAA-01976-6	09.3200.360	--
APAA-01983-3	20.2710.500	--
P105367C15	20.2480.210H	77
P107424C10	20.2480.216H	38,50,73,77
P119170C-3	61.2910.003.001	75
P119170C-4	61.2910.004.001	75
P119170C8	15.2780.840	39,41,75
PAA01976-1	51.3731.326	38,73
PAA019762	15.3731.470H	18,38,73
PAA019763	15.2711.114	38,73
PAA019771	51.3732.326	38,73
PAA019774	15.2712.114	38,73
PAA-01985	09.3200.220	76
<b>Renault</b>		
5001856290	61.3481.149H	19,58
5010578503	59.3900.123H	57
5010578504	59.3900.223H	57
5010578505	59.3901.123H	--
5010578506	59.3901.223H	--
5010578511	59.5580.247H	22,58,61
5010623057	20.3900.510H	56,57,61
5010623058	20.3900.520H	56,57,61
5010623231	59.3900.143H	56,61
5010623232	59.3900.243H	56,61
5010623246	59.3900.133H	56,61
5010623247	59.3900.233H	61
5010623689	59.3901.143H	--
5010623690	59.3901.243H	--
5010623698	59.3901.233H	--
7420849799	59.5524.748.099	--
7420849835	59.5524.649.099	57
7420849837	59.5524.648.099	57,61
7420849852	59.5524.640.099	--
7420850409	20.5520.250H	--
7420862779	11.3900.200H	56,61
7420862782	61.3900.100H	56,57,61
7420862795	15.3900.840H	56,57,61
7420862800	11.3910.200H	56,61
7420862809	61.3911.110H	56,61
7420862810	15.3911.871H	56,61
7420862812	08.5752.024.099	22,39,40,56,57,61
7420862813	61.3911.120H	56,61
7420862815	15.3911.872H	56,61
7420866665	61.3900.110H	56,57,61
7420866672	08.5752.024.099	22,39,40,56,57,61
7420903714	11.3900.201H	--
7420903722	58.3900.143H	--
7420903723	58.3900.133H	--
7420903727	58.3900.243H	--
7420903732	58.3900.233H	--
7420903736	11.3910.201H	--

OE		
<b>Renault</b>		
7420903880	11.3900.100H	57
7420903881	11.3900.101H	--
7420913815	61.3900.120H	22,56,57,61
7421020285	51.5524.930H	22,57,61,67
7421164788	59.5524.730.099	--
7421276373	61.3482.149H	19,58
7421326526	59.3900.233H	22,61
7421326527	59.3900.243H	22,56,61
7421326550	59.3900.223H	--
7421326551	59.3901.223H	--
7421326554	59.3901.233H	--
7421326558	59.3901.243H	--
7421346867	20.5520.250H	--
7421614025	09.3900.003.000	22,56,57,61
7421618499	08.5752.024.099	22,39,40,56,57,61
7478493162	59.1025.003.099	--
7482226023	59.5524.640.099	--
7482226025	59.5524.648.099	57,61
7482226027	59.5524.649.099	57
7482665705	59.5524.748.099	--
7484531138	59.1025.001.099	21,58,62
7484531168	59.1025.002.099	21,58,62
7485120820	61.3900.120H	22,56,57,61
<b>Scania</b>		
102088 / 2081428	55.3000.117	--
108832	11.3001.100	--
129429	20.2700.200H	38,73
1441529	59.2706.121	--
1441530	59.2706.101	--
1441533	59.2706.124	--
1441534	59.2706.104H	--
1448217	20.2480.210H	77
1451226	20.2480.216H	38,50,73,77
1451227	20.2480.211H	77
1485117	59.2706.203	--
1485118	59.2706.232	--
1505201	15.3731.470H	18,38,73
1505202	11.3730.210H	18,23,38,68,73
1505203	61.2708.842H	79
1522365	21.2706.100	--
1522366	21.2706.110	--
1522367	09.3200.360	--
1527773	59.5581.100H	59
1543451	51.2510.127H	28
1742422	09.3200.310H	--
1763444	51.1524.117	--
1767265	15.4001.740H	59
1805203	51.3732.326	38,73
1857128	59.2706.302	--
1880287	20.2710.121	73
1880288	20.2710.111H	73
1880289	59.2715.101.099	75
1880290	59.2715.102	--
1880295	20.2710.200H	38,73
1886454	40.2510.222H	28
1893487	51.3635.206	23,68
1893489	15.3802.840H	23,68
1893532	51.3731.326	38,73
1895048	51.3732.326	38,73
1915758	20.2700.260	--
1946640	15.2712.113F	--
2081428	55.3000.108H	--
2092223	55.2462.117	--
2092593	08.5752.024.099	22,39,40,56,57,61
2116845	19.1019.013.099	59
2116846	19.1019.014.099	59
2116848	19.1019.313.099	59
2116849	19.1019.314.099	59
2127721	55.2561.111.001	--
2239699	59.2706.005.001	--
22479890	11.2770.920	40
2248592	56.2660.002.099	27
2252649	58.2706.002.001	--
2252652	58.2706.104H	--
2332206	09.3200.320H	76
2382791	59.1005.003.099	59
2411114	59.2770.210.099	40
2434918	55.2561.111.001	--
2530656	09.2910.002.099	72,75
2530662	59.2910.004.001	74
2530663	59.2910.001.001	74
2537657	61.2910.009.002	--
2537709	11.2910.003.000	75
2537712	11.2910.011.002	75
2537714	19.2910.001.099	41,75
2537717	61.2910.011.002	--
2537719	11.2910.008.000	75
2537720	11.2910.012.002	75
2537722	61.2910.020.002	--
2537723	11.2910.017.000	--
2537726	61.2910.012.002	--
2541253	61.2910.005.001	75
2541254	11.2910.001.000	75
2541255	11.2910.002.000	75
2541259	61.2910.006.001	75
2541260	11.2910.006.000	75

OE		
<b>Scania</b>		
2541261	11.2910.007.000	75
2541262	19.2910.002.099	41,75
2548189	15.2780.840	39,41,75
2556182	59.2782.120	--
2567224	59.2910.010.001	74
2567225	59.2910.017.001	74
2577310	09.3200.330	--
2599501	61.2910.019.002	--
2599528	61.2910.010.002	--
2599529	11.2910.014.000	--
2599530	11.2910.016.000	--
2723896	59.2770.310.099	40
2728569	59.2770.211.099	40
2729143	59.1041.001.099	41
2729156	59.1042.003.099	41
2729158	59.1042.001.099	41
2739165	11.2770.102	40
2739167	15.2771.840	40
2739168	15.2771.870	40
2760509	59.2910.012.001	74
2794079	08.2910.001.002	40,75
2911918	09.1041.002.099	41
2926677	15.2780.870	39
3070159	51.3000.002.001	67
3070160	61.3000.004.001	67
3139595	08.1024.124.099	41
437489	51.2540.148	--
437491	58.2481.012	--
639093	14.2530.100	--
639141	61.2530.110H	42
9006839	05.3308.100	--
<b>SIAC</b>		
166351394	40.1009.004.099	69
166352077	40.1009.002.099	69
166428555 - ALT	51.1009.048.099	--
447419568	55.2021.177	--
620031733 - ALT	59.1017.003.099	70
620031734 - ALT	59.1017.004.099	70
620102328 - ALT	51.1009.017.099	69
<b>SIAC</b>		
620102331 - ALT	51.1009.113.001	--
620102332 - ALT	51.1009.009.099	69
6201020281 - ALT	58.1017.005.099	70
6201020282 - ALT	58.1017.006.099	70
6201020283 - ALT	58.1017.011.099	70
6201020284 - ALT	58.1017.012.099	70
620186052	09.3200.420H	26,69,71
<b>SOLARIS</b>		
0000-059-207	11.2770.102	40
0000-059-214	11.2770.202	40
0000-059-216	11.2770.302	40
0000-059-218	11.2770.402	40
0000-059-220	11.2770.920	40
0000-059-224	61.2770.210	40

# Vergleichsliste nach OE-Nummern Cross-reference-table

OE		
<b>SOLARIS</b>		
1905-509-000	58.2704.070	79
1905-509-025	58.2704.051H	79
1905-510-000	59.3652.167H	--
1905-511-000	59.2640.110H	--
1905-530-080	40.2530.422H	42
1905731470	15.3731.470H	18,38,73
1905770210	11.3730.210H	18,23,38,68,73
1905-770-210	11.3730.210H	18,23,38,68,73
1970018000	20.2480.216H	38,50,73,77
1970-018-000	20.2480.216H	38,50,73,77
1970-019-000	20.2480.217H	38,50,73,77
5300-008-114	15.2561.600	--
5300-009-015	11.2780.510	--
<b>Steyr</b>		
16100770103	51.2890.117H	68
<b>Tatra</b>		
443332031000	40.3305.218	--
443332032	40.3302.418H	--
443332041000	51.3300.149	--
443332042000	59.3601.128H	60
443332051000	51.3635.206	23,68
443332052000	51.3636.206	23,68
443332058000	51.3635.216	--
443332059000	51.3636.216	--
443400151000	51.3300.147H	--
990115703000	15.3802.840H	23,68
990115704000	40.3605.203H	60
<b>Temsa</b>		
5053APA03Y	61.2910.004.001	75
5053APA0401Y	15.2780.840	39,41,75
5053APA0403Y	19.2910.001.099	41,75
5053APA04Y	59.2910.002.001	74
5053APA05Y	61.2910.003.001	75
5053APA06Y	59.2910.001.001	74
HD301144-02Y	19.2910.002.099	41,75
HD3011444Y	59.2910.004.001	74
HD301151Y	61.2910.006.001	75
<b>Temsa</b>		
HD301152	61.2910.005.001	75
MD301145Y	59.2910.010.001	74
<b>Terex</b>		
103724	51.1523.121H	--
105518	55.2020.171	--
27230912	59.5524.530H	67
48092012	15.3802.840H	23,68
5253100003	51.3640.127	--
5653634760	51.1523.111H	--
5653634770	51.1524.118	--
5653634775	51.2500.127H	60
5653634816	51.2500.147H	60
5653634822	51.2493.137H	--
5653634825	51.1009.017.099	69
5653634830	51.1009.089.099	--
5653634836	40.1009.001.000	69
5653634837	40.1009.002.000	69
<b>VDL</b>		
20510114	51.2530.148H	--
24012180000	51.2530.128H	--
28250087	55.2561.110	--
30014897	59.2770.210.099	40
30014898	59.2780.120.099	39
30016869	11.2780.910	39
30017252	15.2780.870	39
30017729	59.2710.402H	73
30017737	51.3732.326	38,73
30017741	15.3731.470H	18,38,73
30017752	11.3730.210H	18,23,38,68,73
30017839	55.2561.010	--
30017840	15.2561.640	--
30017844	15.2771.870	40
30017845	20.2780.630	--
30017846	15.2780.840	39,41,75
30017876	15.2780.840	39,41,75
30022423	51.3731.326	38,73
30032132	55.2561.110	--
30045213	11.2770.202	40
30045214	11.2770.302	40
30045215	11.2770.402	40
30102976	20.2710.630	--
30103263	11.2780.510	--
30103281	61.2770.210	40
30103282	61.2770.211	40
30103284	11.2780.920	39
30103285	11.2780.520	--
30103286	59.2780.150.001	39
30110912	09.2910.006.001	--
30120778	59.2712.111	38
30120779	59.2712.114	38
30120780	20.2480.222	--
30120781	20.2480.221	--
30121356	59.2910.024.001	--
30121358	59.2910.023.001	--

OE		
<b>VDL</b>		
30121380	61.2910.027.001	--
30121381	61.2910.026.001	--
30127115	59.2706.006.001	--
30130954	51.3635.206	23,68
30130955	15.3802.840H	23,68
30130962	11.2910.001.000	75
30130963	11.2910.006.000	75
30130964	11.2910.003.000	75
30130965	11.2910.008.000	75
30130967	11.2910.012.000	--
30130970	61.2910.009.002	--
30130971	61.2910.019.002	--
30130972	19.2910.001.099	41,75
30130975	61.2910.010.002	--
30130976	61.2910.020.002	--
30130977	11.2910.016.000	--
30130978	11.2910.017.000	--
30130979	11.2910.014.000	--
30130981	19.2910.002.099	41,75
30130982	61.2910.011.002	--
30130983	61.2910.012.002	--
30130985	20.2480.216H	38,50,73,77
30130986	11.2910.007.000	75
30130988	59.2910.027.001	75
30130989	55.3000.117	--
30162331	61.3000.002.001	67
30172295	59.2760.007.001	--
30172762	11.2770.040	40
30172766	61.2770.900.099	40
30184984	61.2910.006.001	75
30184985	61.2910.005.001	75
30207377	59.2910.500.001	--
30218618	20.2760.140	--
30218619	20.2760.150	--
30218620	51.3636.206	23,68
30218738	09.2910.003.099	40,75
30218739	08.3950.001.099	40,75
30226914	12.1018.002.099	72
30226915	19.1018.314.000	--
30243430	12.1018.001.099	72
31041266	08.2910.001.002	40,75
53707213480217	20.2480.217H	38,50,73,77
60000269	58.260.1.010	--
60000270	09.3200.320H	76
H28250077	51.2500.167H	--
HJ24013370	51.3850.147H	66
J24013361200	09.3200.320H	76
P758200126	59.2710.401H	73
P759001645	20.2480.216H	38,50,73,77
P759001646	20.2480.217H	38,50,73,77
<b>Viseon</b>		
44152400300	09.2910.002.099	72,75
44176040317	59.2910.001.001	74
44176040318	59.2910.002.001	74
44176040321	59.2910.003.001	74
44176040322	59.2910.004.001	74
<b>Volvo</b>		
22210899	58.2704.065	--
0331121	20.2710.121	73
1096643	59.3601.128H	60
1581550	51.2500.127H	60
1581599	40.2500.222H	60
1581602	40.2500.422H	60
1581616	51.2500.147H	60
1594411	51.2500.147H	60
1594412	51.2500.147H	60
1594415	40.2500.422H	60
1594902 / 1621353 /		
1195934 / 3090396	51.2520.147H	60
1599462	51.2520.127H	60
161 00 77 0005	51.3200.147H	26
16281990	51.1009.025.099	69
16315898	55.2020.177H	--
1697007	40.2520.422H	60
1697927	14.2530.100	--
1697928	61.2530.110H	42
17452496	511090917099	--
20207881	59.3900.143H	22,56,61
20515454	20.2480.223	77
20523873	59.2710.410	--
20523877	59.2710.409	--
20526284	09.3200.320H	76
20526353	56.2660.127H	27
20540638	20.2710.500	--
20548032	56.2660.147H	27
20548137	58.2600.010H	--
20564284	58.2704.086	79
20567670	15.2240.840H	62
20707812	59.5580.247H	22,58,61
20707874	59.3900.133H	22,56,61
20707881	59.3900.143H	22,56,61
20708110	20.3900.510H	22,56,57,61
20708230	20.3900.520H	22,56,57,61
20708303	59.3900.233H	22,56,61
20743983	59.3900.243H	22,56,61

OE		
<b>Volvo</b>		
20849837	59.5524.648.099	57,61
20854088	20.2480.211H	77
20854564	15.3702.470H	60
20854568	15.3712.410H	--
20854576	40.2520.422H	60
20854583	40.3605.204F	60
20862779	11.3900.200H	22,56,61
20862782	61.3900.100H	22,56,57,61
20862795	15.3900.840H	22,56,57,61
20862800	11.3910.200H	22,56,61
20862809	61.3911.110H	22,56,61
20862810	15.3911.871H	22,56,61
20862812	08.5752.024.099	22,39,40,56,57,61
20862813	61.3911.120H	22,56,61
20862815	15.3911.872H	22,56,61
20866665	61.3900.110H	22,56,57,61
20866672	08.5752.024.099	22,39,40,56,57,61
20903722	58.3900.143H	22,56,57,61
20903723	58.3900.133H	22,56,61
20903727	58.3900.143H	22,56,57,61
20903732	58.3900.233H	22,56,61
20925244	08.3200.233H	39,40,72,75,76
20970652	51.3850.197H	66
20970794	61.3000.002.001	67
21020285	51.5524.930H	22,57,61,67
21070768	15.2242.870H	--
21083501	56.2600.147H	26
21083541	09.2070.101H	26,28,42,60,68,76
21150393	55.2561.110	--
21203313	59.3601.178H	60
21310517	51.2480.150H	--
21314080	55.3000.117	--
21320365	15.2242.870H	--
21320383	15.2240.840H	62
21326526	59.3900.233H	22,56,61
21326527	59.3900.243H	22,56,61
21386593	15.2712.113F	73
21462625	58.2704.065	--
21475603	59.3900.233H	22,56,61
21614025	09.3900.003.000	22,56,57,61
21618499	08.5752.024.099	22,39,40,56,57,61
21879369	59.2910.001.001	74
21879404	59.2910.004.001	74
21885961 / 22117455	61.2910.002.001	75
21885962	61.2910.005.001	75
21885963	61.2910.006.001	75
21885964	61.2910.003.001	75
21885965	61.2910.008.001	75
21894545	59.2910.002.001	74
21922258	59.2910.005.001	74
22026461	20.2710.650	39
22026977	59.2910.008.001	74
22033845	12.1018.001.099	72
22033846	12.1018.002.099	72
22033847	15.2780.840	39,41,75
22033849	19.1018.314.000	--
22038103	09.2910.002.099	72,75
22038110	08.3950.001.099	40,75
22117132	11.2910.003.000	75
22117135	1	



# Cross-reference-table Vergleichsliste nach OE-Nummern

OE		
Volvo		
22479675	11.2780.910	39
22479729	20.2780.630	--
22479736	11.2780.510	--
224798	15.2780.840	39,41,75
22479822	15.2780.870	39
22479887	11.2770.102	40
22479899	11.2770.040	--
22479901	11.2770.520H	--
22479903	61.2770.901.099	40
22479907	11.2770.202	40
22479912	15.2771.840	40
22479913	15.2771.870	40
22480056	11.2770.302	40
22480060	11.2770.402	40
22480148	61.2770.210	40
22480159	61.2770.900.099	--
22480393	09.2770.110H	--
22488075 / 22117241	08.2910.001.002	40,75
22526136	59.2910.023.001	--
22526143	59.2910.027.001	--
22544279	59.2910.024.001	--
22548216	61.2910.004.001	75
22836792	59.2910.007.001	74
22838596	59.2760.007.001	--
22847902	51.3635.206	23,68
22847915	11.3730.210H	18,23,38,68,73
22847920	15.3802.840H	23,68
23120356	58.2706.104H	--
23200690	51.7504.044.001	67
23238988	20.2710.121	73
23286290	20.7504.044.001	67
23286294	20.7504.003.001	67
23329006	59.2910.006.001	74
23614948	20.2760.140	--
23614972	20.2760.150	--
23647983	05.3308.100	--
23655694	09.2710.200	--
23946968	59.2910.014.001	74
23946969	59.2910.013.001	74
24015370	19.1000.121.099	63
24015373	19.1000.122.099	63
24018790	51.3000.002.001	67
24018822	61.3000.004.010	67
2739166	11.2770.920	40
3090395	51.2520.127H	60
3090734	40.3605.204F	60
3090737	15.3702.470H	60
3090739	15.3712.410H	--
3091256	61.3700.231H	--
3091257	61.3700.241H	--
3091258	61.3710.241H	--
3091259	61.3710.231H	--
3091750	58.3701.130H	--
3091751	58.3701.140H	--
3091756	15.3702.470H	60
3091757	15.3712.410H	--
3092854	15.3702.470H	60
3093944	59.2715.101.099	73
3093945	59.2715.102	--
3098470	40.3640.422H	26,28
3126117	59.3602.128H	60
3980924	59.3702.231H	--
3980926	59.3702.431H	--
3980933	59.3712.241H	--
3980935	59.3712.441H	--
5.899.90.057.81	40.3640.422H	26,28
5.899.90.058.03	51.2540.128	--
52510003	56.2630.127	--
589990057800	51.3410.147H	26
589990057960	51.2540.148	--
5899900579601	40.2540.422H	42
582710409	59.2710.409	--
6795142	51.2520.177	--
703060536	15.2712.113F	73
70309620	58.2705.001H	79
70309627	51.3731.326	38,73
70309630	58.2704.059	--
70310107	56.2630.127	--
70310110	11.1523.212	--
70328278	59.2710.401H	73
70328289	59.2710.406	73
70328290	20.2710.121	73
70328291	59.2706.104H	--
70328294	58.2704.070	79
70331012	15.2712.114	38,73
70331060	58.2704.044	79
70331062	51.1524.117	--
70331063	51.2500.167H	--
70331119	20.2700.240	--
70331120	20.2700.230	--
70331122	20.2710.111H	73
70331123	20.2480.217H	38,50,73,77
7033112370348002	20.2480.217H	38,50,73,77
70331124	20.2480.216H	38,50,73,77
70331940	59.2762.322	38
70331941	20.2710.620	38,39,77
70332172	58.2704.078	--

OE		
Volvo		
70348000	59.2715.101.099	--
70348001	59.2715.102	--
70348002	20.2480.216H	38,50,73,77
70348003	20.2480.216H	38,50,73,77
70348066	09.3200.220	76
70352000	58.2705.003	79
70352646	20.2480.210H	77
70360528	20.2710.132D	--
70360529	20.2480.222	--
70360530	20.2710.200H	38,73
70360531	58.2710.101	--
70360533	11.3730.210H	18,23,38,68,73
70360534	20.2710.142D	--
70360538	08.3491.325.000	--
70360538 / 8706271900051	08.3492.324.099	--
70369682	51.3732.326	38,73
73028283	59.2710.402H	73
82356808	13.1043.001.000	63
82356810	19.1000.101.099	63
82356824	19.1000.103.099	63
82359213	13.1043.001.000	63
82359214	19.1000.102.099	63
82417041	40.5725.412H	29,62
82417042	11.5721.001.099	29,62
82417044	40.5735.403H	29,62
82417045	11.5731.001.099	29,62
82471688	61.5721.005.099	62
82471689	61.5731.001.099	--
82471690	61.5721.006.099	62
82472612	61.5721.004.099	29,62
8350002289	09.2070.101H	26,28,42,60,68,76
8350026023	09.3400.440	--
8350035653	51.3731.326	38,73
8350035654	51.3732.326	38,73
8350035655	09.3200.220	76
8350042502	59.2710.401H	73
8350045482	20.2700.240	--
8350045484	20.2700.230	--
8350046432	20.2480.217H	38,50,73,77
8350046433	20.2710.200H	38,73
8350046555	11.3730.210H	18,23,38,68,73
8350046557	15.2712.114	38,73
8350046970	20.2710.111H	73
8350046971	20.2480.216H	38,50,73,77
83550046556	15.2711.114	38,73
84531138	59.1025.001.099	21,58,62
84531168	59.1025.002.099	21,58,62
85104654	20.2700.260	--
85104656	20.2700.200H	38,73
85120820	61.3900.130H	22,56,57,61
8690002311	40.3005.222	--
8706271900014	59.2715.101.099	--
8706271900014 / 70348000	59.2715.101	--
8706271900015	59.2715.102	--
8706271900018	20.2480.217H	38,50,73,77
8706271900020	20.2710.111H	73
8706271900021	09.3200.220	76
8706271900030	15.3731.470H	18,38,73
8706271900031 / 20565735	59.2705.000	--
8706271900052	11.3730.210H	18,23,38,68,73
8706271900058	58.2704.059	--
8706271900059	51.3731.326	38,73
8706271900060	51.3732.326	38,73
8706271900055	20.2480.210H	77
8706331900007	56.3491.110H	51,63
8706331900008	56.3492.110H	51,63
VW		
2D0 857 537 C	11.3491.200	--
2D0 959 577	08.3491.313.000	--
2D3 857 501 D	59.3496.110V	--
2D0857521	15.3491.071H	51,63
2D0857521A	15.3491.371H	51,63
2D0857522	15.3491.072H	51,63
2D0857522A	15.3491.372H	51,63
2D1857501A01C	51.3495.110H	63
2D1857501C01C	51.3495.112H	63
2D1857502A01C	51.3495.120H	63
2D1857502C01C	51.3495.122H	63
2E0857513B	51.5894.310.199	52
2E0857513C	51.5894.112.199	--
2E0857514A	51.5894.410.199	52,64
2E0857514B	51.5894.212.199	--
2E0857527	13.5890.120.099	53,55,65
2E0857528	13.5890.220.099	53,55,65
2E0857587A	19.5890.011.099	53,55,65
2E0857587B	19.5891.011.099	53,65
2E0857588B	19.5891.012.099	53,65
2E0919473	08.5890.300.099	53,65
2E0919473A	08.5890.301.099	53,65
2E0945981	08.5892.105.099	53,55,65
2E0950050A	08.5892.003.099	53,55,65
2E0953049A	08.5892.001.099	53,65
2E0953049B	08.5892.004.099	53,65

OE		
VW		
2E0953049C	08.5892.002.099	53,55,65
2E0953050A	08.5892.004.099	53,65
2E0953050C	08.5892.003.099	53,55,65
2E1857136	14.5890.100.099	53,55,65
2E1857136A	14.5890.200.099	53,55,65
2E1857501AJ	51.5891.111.199	52,64
2E1857501AK	51.5892.111.199	52,64
2E1857501AL	51.5893.111.199	52,64
2E1857501E	51.5891.111.199	52,64
2E1857501F	51.5891.113.199	52,64
2E1857501G	51.5891.112.199	--
2E1857501R	51.5892.112.199	--
2E1857502AK	51.5891.211.199	52,64
2E1857502AL	51.5892.211.199	52,64
2E1857502AM	51.5893.211.199	52,64
2E1857502D	51.5892.211.199	52,64
2E1857502E	51.5891.211.199	52,64
2E1857502F	51.5891.213.199	52,64
2E1857502P	51.5891.212.199	--
2E1857502Q	51.5892.212.199	--
2E1857516A	13.5890.110.199	53,55,65
2E1857516B	13.5890.210.199	53,55,65
2E1857587	15.5891.741H	53,65
2E1857587A	15.5891.611H	53,65
2E1857587E	15.5891.721.099	53,55,65
2E1857588	15.5891.742H	53,65
2E1857588A	15.5891.612H	53,65
2E1857588E	15.5891.722.099	53,55,65
2E2857501C	51.5891.311.199	52,64
2E2857501D	51.5891.313.199	52,64
2E2857501F	51.5891.312.199	--
2E2857501G	51.5892.312.199	--
2E2857501H	51.5891.311.199	52,64
2E2857502C	51.5891.411.199	52,64
2E2857502D	51.5891.413.199	52,64
2E2857502F	51.5891.412.199	--
2E2857502G	51.5892.412.199	--
2E2857502N	51.5891.411.199	52,64
2E3857501D	51.5892.211.199	52,64
2E3857501E	51.5893.111.199	52,64
2E3857501F	51.5892.213.199	52,64
2E3857501G	51.5893.113.199	52,64
2E3857501H	51.5893.112.199	--
2E3857501J	51.5891.114.199	--
2E3857502E	51.5893.211.199	52,64
2E3857502F	51.5892.213.199	52,64
2E3857502G	51.5893.213.199	52,64
2E3857502J	51.5893.212.199	--
2E3857502K	51.5891.	

# DAF

65 CF, 75 CF,  
85 CF, 95 XF  
alternativ 75 / 85 / 95  
03/00 - 04/06  
09/92



<b>373</b>	II [e1] 02★0423		ABS	Ø 28 mm
	II (E1) 010423			

MEKRA LANG Group	Beschreibung description descripção descripziõe descripcción benjämning Popis omrcaavre örellek leirats opis						mm	OE
	61.3730.324H		384 x 205 x 120	1425 104 + 1610 186				
	15.3731.470H		369 x 190 x 42	1425 109 + 1610 190				
	11.3730.210H		367 x 187 x 60	1425 113				
	61.3730.326H		384 x 205 x 120	1425 105 + 1610 184				
	15.3731.470H		369 x 190 x 42	1425 109 + 1610 190				
	11.3730.210H		367 x 187 x 60	1425 113				

<b>386</b> <b>386-1</b>	IV [e1] 02★0424		ABS	Ø 28 mm
	IV (E1) 010424			
	IV [e1] 03★0023			

MEKRA LANG Group	Beschreibung description descripção descripziõe descripcción benjämning Popis omrcaavre örellek leirats opis						mm	OE
	61.3860.214H		219 x 170 x 120	1425 108 + 1610 187				
	15.3861.114H		203 x 154 x 36	1425 111 + 1610 191				
	11.3860.500H		203 x 154 x 60	1425 114				
	61.3865.124H		219 x 170 x 120	1610 189				
	15.3862.174H		203 x 154 x 36	1610 182				
	11.3860.500H		203 x 154 x 60	1425 114				

<b>906</b>	IV [e1] 03★0014		ABS	Ø 28 mm

MEKRA LANG Group	Beschreibung description descripção descripziõe descripcción benjämning Popis omrcaavre örellek leirats opis						mm	OE
	61.9065.114H		209 x 218 x 136	1670 877				
	15.9060.870H		204 x 195 x 58	1670 878				
	11.9060.100H		202 x 194 x 55	1670 888				
	56.9065.110		209 x 218 x 136					
	15.9060.870H		204 x 195 x 58	1670 878				
	11.9060.100H		202 x 194 x 55	1670 888				
	61.3860.100		210 x 9 ø					

# DAF

348	II  03★0184				Ø 22 mm	
	II  021022					
		Beschreibung description description descrizione description benámening popis özeňlik leirás opis		 mm		OE
61.3481.149H	    		395 x 205 x 145	1805 714		
15.3480.840H	  		372 x 189 x 32	1805 717		
11.3480.100			169 x 88 x 27			
61.3480.149H	    		382 x 193 x 85	1405 295 * 1805 712 1404 871		
40.3485.412H	  		375 x 190 x 3	1805 713		

LF 45/55



348	IV  03★0185				Ø 22 mm	
	IV  021023					
		Beschreibung description description descrizione description benámening popis özeňlik leirás opis		 mm		OE
61.3482.149H	    		199 x 199 x 97	1796 324 * 1404 868 1405 350		
40.3485.403H	  		191 x 191 x 3	1796 325 * 1404 849		



XF 95, XF 105, XF 106  
CF 65/75/85  
JOHN DEERE

01/06  
05/06  
10/11



XF 95, XF 105, XF 106

02/13



# DAF

<b>570</b>	II e1 03★0007 II (E1) 02 1251			Ø 40 mm
------------	----------------------------------	--	--	---------

MEKRA LANG Group		Beschreibung / description / descripción / descrizione / descripción / benämning / popis / omicaune / čerilnik / leirrás / optis				mm	OE
61.5700.210H		24V	411 x 228 x 140	1692 557			
61.5700.310.099		24V	411 x 228 x 140	1812 862 + 1689 348			
15.5701.840H		24V	363 x 177 x 25	1685 330 AL 20 31 51 (John Deere)			
11.5700.100H			411 x 228 x 110	1644 325			
09.5700.001.099			250 x 6 Ø				

<b>571 574</b>	IV e1 03★0008 IV (E1) 02 1252 IV (E1) 02 1253			Ø 40 mm
--------------------	---	--	--	---------

MEKRA LANG Group		Beschreibung / description / descripción / descrizione / descripción / benämning / popis / omicaune / čerilnik / leirrás / optis				mm	OE
------------------	--	--	--	--	--	----	----

EURO 5	61.5710.210H		24V	239 x 221 x 140	1692 556	
	61.5710.310.099		24V	239 x 221 x 140	1817 860 + 1689 347	
	15.5711.870H		24V	207 x 161 x 35	1685 331	
	11.5710.110H			239 x 221 x 118	1644 326 + 1659249	
	09.5700.002.099			250 x 6 Ø	1812 865	

EURO 6	61.5710.310.099		24V	239 x 221 x 140	1817 860 + 1689 347	
	15.5711.870H		24V	207 x 161 x 35	1685 331	
	11.5710.110H			239 x 221 x 118	1644 326 + 1659249	
	61.5740.001.099		24V	245 x 243 x 140	1940 341	
	19.5740.311.099		24V	211 x 192 x 40	1940 342	
12.5740.002.099			245 x 240 x 118	1882 113		

<b>559</b>	VI (E1) 021039 VI e1 03★0196			INTEGR.
------------	---------------------------------	--	--	---------

MEKRA LANG Group		Beschreibung / description / descripción / descrizione / descripción / benämning / popis / omicaune / čerilnik / leirrás / optis				mm	OE
------------------	--	--	--	--	--	----	----

XF	59.5595.235H			411 x 375 x 285	1684 042 + 1816 912	
	59.5595.236			411 x 375 x 285	1684 043 + 1816 913	
XF	59.5595.331H			1007 x 320 x 220	1684 046 + 1816 914	
	59.5595.332			1007 x 320 x 220	1684 047 + 1816 915	
CF	59.5595.131H			437 x 433 x 383	1684 030 + 1816 902	
	59.5595.132H			437 x 433 x 383	1684 031 + 1816 903	
	61.5590.001.099		240	256 x 165 x 82	1830 338	
	20.5521.100H		für for pour	110 x 53 x 51	1698 180	

# DAF

<b>552</b> <b>552-1</b>	V  02★0742 V VI  03★0033 V VI  020894			
	Beschreibung description descripção descrizione description benamning popis описання özellik leirás opis			
59.5520.230H		319 x 187 x 50	1669 573	XF
59.5520.130H		319 x 187 x 50		CF

*XF 95, XF 105, XF 106*  
*CF 65/75/85*  
*01/06*  
*05/06*



XF



CF

*New Regulation ECE R46/04*

<b>1005</b>	V  04★1336 V  041336			
	Beschreibung description descripção descrizione description benamning popis описання özellik leirás opis			
59.1005.001.099		326 x 202 x 214	1949 304	CF
59.1005.002.099		326 x 202 x 214	1949 305	XF



*LF 45/55*

*New Regulation ECE R46/04*

<b>1025</b>	V  04★1345			
	Beschreibung description descripção descrizione description benamning popis описання özellik leirás opis			
59.1025.001.099		315 x 179 x 220	1709 390	LF
59.1025.002.099		315 x 179 x 220	1709 389	



<b>570 A</b>			Ø 40 mm	
	Beschreibung description descripção descrizione description benamning popis описання özellik leirás opis			
58.5701.104.099		818 x 40 ø	1685 324 ÷ 1812 867	XF EURO 5
58.5700.001.099		818 x 40 ø	1685 325 ÷ 1830 562	
58.5700.003.002		818 x 40 ø	1940334	
58.5700.004.002		818 x 40 ø	1940335	
58.5713.114.099		920 x 40 ø	1788 972 ÷ 1812 859	CF
58.5710.001.099		920 x 40 ø	1788 487 ÷ 1818 353	
20.5700.410H		145 x 98 x 68	1644 324	XF EURO 5
20.5700.420H		145 x 98 x 68	1644 323	
12.5700.001.099		304 x 113 x 82	1882 126	XF EURO 6
12.5700.002.099		205 x 78 x 45	1882 111	
12.5700.003.099		304 x 113 x 82	1882 127	
12.5700.004.099		205 x 78 x 45	1882 112	



# DAF

XF / XG / XG+  
New Generation

10/2020



<b>1027</b>	<b>NEW</b>	II (E1) 041619 IV (E1) 041620			<b>INTEGR.</b>
-------------	------------	----------------------------------	--	--	----------------

	Beschreibung description description descripção descripzione descripção beznámením popis omričnice древлик releaz opis		mm	
--	---	--	----	--

<b>LHD</b>	59.1027.001.099		1014 x 397 x 200	2248 157			
	59.1027.002.099		1014 x 414 x 258	2248 158			
	<b>RHD</b>	59.1027.003.099		1014 x 414 x 258	2248 175		
		59.1027.004.099		1014 x 397 x 200	2248 176		
<b>a</b>	12.1027.005.099		main mirror	1	701 x 248 x 154	2248 166	
	12.1027.107.099		main mirror	2	701 x 248 x 154	2248 172	
	12.1027.207.099		main mirror	3	701 x 248 x 154	2298 826	
	12.1027.006.099		main mirror	4	701 x 248 x 154	2248 167	
	12.1027.108.099		main mirror	5	701 x 248 x 154	2248 173	
	12.1027.208.099		main mirror	6	701 x 248 x 154	2298 827	
<b>b</b>	12.1027.001.099		upper foot	7	205 x 103 x 98	2248 164	
	12.1027.002.099		upper foot	8	205 x 103 x 98	2248 165	
<b>c</b>	12.1027.103.099		lower foot	9	266 x 177 x 114	2248 160	
	12.1027.203.099		lower foot	10	266 x 177 x 114	2298 758	
	12.1027.104.099		lower foot	11	266 x 177 x 114	2248 161	
	12.1027.204.099		lower foot	12	266 x 177 x 114	2298 759	
<b>d</b>	19.1027.011.099			13	384 x 200 x 42	2306 590	
	19.1027.012.099			14	384 x 200 x 42	2306 591	
	19.1027.311.099			15	209 x 210 x 52	2306 592	
	19.1027.312.099			16	209 x 210 x 52	2306 593	
	12.1027.015.099		neck	17	176 x 164 x 79	2248 168	
	12.1027.016.099		neck	18	176 x 164 x 79	2248 169	
	61.1029.224.099			19	130 x 125 x 50	2306 586	
	61.1024.224.099			20	130 x 125 x 50	2306 587	

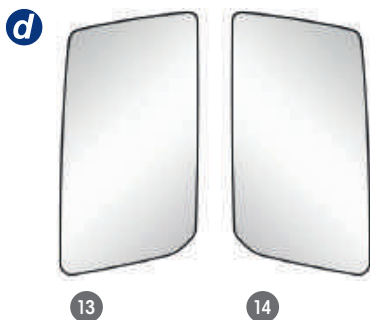

# DAF

559	<b>NEW</b>	VI (E1) 021039			INTEGR.	
		VI (e1) 03★0196				
		Beschreibung description descripción descrizione beňnapišning popis optiskanne detalik leirás opis		 mm		OE
59.5590.013.099					450 x 491 x 217	2248 178
59.5590.014.099					450 x 491 x 217	2248 179
12.5590.009.099					1 209 x 128 x 70	2248 184

*XF / XG / XG+  
New Generation*



10/2020

1005	<b>NEW</b>	V (e1) 04★1336				
		V (E) 041336				
		Beschreibung description descripción descrizione beňnapišning popis optiskanne detalik leirás opis		 mm		OE
59.1005.011.099					330 x 233 x 205	2248 159
12.1005.001.099					2 121 x 78 x 52	2248 174

*XF / XG / XG+  
New Generation*



10/2020

IVECO

Stralis  
Trakker  
Eurocargo  
Tector

04/06  
04/06  
04/06  
04/06



# IVECO

1008		II e3 03★1034 IV e3 03★1036		Truck	ABS	INTEGR.
MEKRA LANG Group		Beschreibung description descripção descripziõe benamning Popis omivkaue üzellik opis		mm	OE	
59.1008.005.099		799 x 370 x 272	504 150 526 + 504 369 910 580 133 4614			
59.1008.006.099		799 x 370 x 272	504 150 527 + 504 369 961 580 133 4610			
59.1008.045H*		799 x 370 x 272	504 150 532			
59.1008.046H*		799 x 370 x 272	504 150 533			
59.1008.011.099		799 x 424 x 287	504 150 538 + 504 370 048 580 133 6285			
59.1008.012.099		799 x 424 x 287	504 150 539 + 504 370 055 580 133 6298			
59.1008.051H*		799 x 424 x 287	504 150 544			
59.1008.052H*		799 x 424 x 287	504 150 545			
59.1008.017.099		811 x 520 x 304	504 150 551 + 504 369 979 580 134 1206			
59.1008.018.099		811 x 520 x 304	504 150 552 + 504 369 995 580 134 1207			
59.1008.057H*		811 x 520 x 304	504 150 557			
59.1008.058H*		811 x 520 x 304	504 150 558			
19.1008.041.099		371 x 181 x 15	504 197 878			
19.1008.311.099		192 x 206 x 20	504 197 879			

\* only available in UK/IRL



1008		V e3 03★1031		Truck	ABS	
MEKRA LANG Group		Beschreibung description descripção descripziõe benamning Popis omivkaue üzellik opis		mm	OE	
56.1008.001.099		270 x 230 x 60	504 168 235			
56.1008.002.099		270 x 230 x 60	504 168 236			
56.1008.003.099*		270 x 230 x 60	504 168 237			
56.1008.004.099*		270 x 230 x 60	504 168 238			
11.1008.001.099		210 x 205 x 100	504 168 244			

\* only available in UK/IRL



# IVECO

<b>1008</b>	VI e3 03★1042			INTEGR.
	Beschreibung description description descricao benämning popis opis opis		OE	
55.1008.002.099		315 x 240 x 60	504 224 428	
55.1008.003.099*		315 x 240 x 60	504 224 429	
55.1008.004.099*		315 x 240 x 60	504 224 430	

\* only available in UK/IRL

Stralis  
Trakker  
Eurocargo  
Tector



IVECO

04/06 - 2019  
04/06  
04/06  
04/06

<b>279</b>	<b>NEW</b>			INTEGR.
	Beschreibung description description descricao benämning popis opis opis		OE	
19.2790.011.099		399 x 222	500 086 749	
19.2790.012.099		399 x 222	500 086 750	
19.2790.031.099		223 x 218	500 086 753	
19.2790.032.099		223 x 218	500 086 754	
11.2790.001.099		640 x 240 x 108	580 249 8968	
11.2790.002.099		640 x 240 x 108	580 249 8969	

S-Way, T-Way



2020

# MAN

M 90, F 90

03/00



<b>320</b>	II [e1] 02★14054 II [e1] 02★14053 II (E1) 0114053	II		Ø 18-30 mm
	Beschreibung description descripcão descripción benamning popis орыцавае üzellik opis		OE	
51.3200.147H		380 x 190 x 100	81.63730-6193	
40.3200.422H		366 x 176 x 3	81.63733-0036	
09.3200.420H		42 x 42 x 54 [2000]	88.25505-0024	

MAN

M 90, F 90

08/88 - 09/94



<b>340</b> <b>341</b>	II [e1] 02★14098 II (E1) 0114098	II		① Ø 14-20 mm ② Ø 20-30 mm
	Beschreibung description descripcão descripción benamning popis орыцавае üzellik opis		OE	
51.3410.127H		377 x 189 x 65	81.63730-6233 + 81.63730-6220	
51.3412.120H		377 x 189 x 65	81.63730-6420	
40.3640.222H		363 x 175 x 3	81.63733-0025 + 81.63733-0030 81.63733-0060	
51.3410.147H		377 x 189 x 65	81.63730-6234 + 81.63730-6221 81.62730-6221	
51.3410.140		377 x 189 x 65		
40.3640.422H		363 x 175 x 3	81.63733-0064 + 81.63733-6003 81.63730-0032 + 81.63730-6003 81.63730-6202 + 85.20000-9601	
10.6121.100		340 x 159		
09.2000.301H		2000 x 9 ø	83.25402-6010	
51.3400.147H		377 x 189 x 65	88.63730-6041 + 85.63730-6015 81.63730-6016	
40.3640.422H		363 x 175 x 3	81.63733-0064 + 81.63733-6003 81.63730-0032 + 81.63730-6003 81.63730-6202 + 85.20000-9601	
09.3400.420		42 x 42 x 54 [2000]		

M 90, F 90

07/88



<b>260</b>	IV [e1] 02★11001	IV		Ø 14-20 mm
	Beschreibung description descripcão descripción benamning popis орыцавае üzellik opis		OE	
56.2600.127H		205 x 158 x 70	81.63730-6206	
40.2605.204H		190 x 143 x 3	81.63733-0042	
56.2600.147H		205 x 158 x 70		
40.2605.204H		190 x 143 x 3	81.63733-0042	
10.6321.100		186 x 130		
09.2070.101H		2070 x 9 ø	81.25432-0149	

# MAN

<b>266</b> <b>266-1</b>	IV V  02★11008			① Ø 14-20 mm
	IV V  0111008			② Ø 20-30 mm
	IV V  0211008			

MEKRA LANG Group	Beschreibung description descripção descrizione benamning popis описание özellik leirás opis	mm	OE
56.2660.127H	<td>214 x 164 x 55</td> <td>81.63730-6421</td>	214 x 164 x 55	81.63730-6421
40.2665.204H			

MAN / VW G 90 (6-9 t) 10/75 - 07/88



# MAN

251	II e1 01★14050	Truck II	ABS	Ø 14-20 mm
MEKRA LANG Group		mm		OE
Beschreibung description descripção descripção descripção benämning pops орисавке özellik leirás opis				
51.2510.127H		318 x 186 x 26	81.63730-6167 + 81.63730-6127	
40.2510.222H		308 x 176 x 3	81.63733-0032	
51.2510.137H		318 x 186 x 26		
40.2510.322H		308 x 176 x 3		
10.6211.100		282 x 162		
09.2070.101H		2070 x 9 Ø	81.25432-0149	
51.2510.147H		318 x 186 x 26	81.63730-6128 + 81.63730-6148	
40.2510.422H		308 x 176 x 3		
10.6221.100		282 x 162		
09.2070.101H		2070 x 9 Ø	81.25432-0149	

10/75 - 07/88

F8, F9



364	II e1 02★14082 II (E1) 0114082	Truck II	ABS	Ø 14-20 mm
MEKRA LANG Group		mm		OE
Beschreibung description descripção descripção descripção benämning pops орисавке özellik leirás opis				
51.3640.127H		376 x 187 x 28	81.63730-6108 + 81.63730-6126 81.63730-6149 + 81.63730-6147 81.63730-6148 + 81.63730-6194	
40.3640.222H		363 x 175 x 3	81.63733-0025 + 81.63733-0030 81.63733-0060	
51.3640.137H		376 x 187 x 28		
40.3640.322H		363 x 175 x 3		
10.6111.100		340 x 159		
09.2070.101H		2070 x 9 Ø	81.25432-0149	
51.3640.147H		376 x 187 x 28	81.63730-6151 + 81.63730-6001	
40.3640.422H		363 x 175 x 3	81.63733-0064 + 81.63733-6003 81.63730-0032 + 81.63730-6003 81.63730-6202 + 85.20000-9601	
10.6121.100		340 x 159		
09.2070.101H		2070 x 9 Ø	81.25432-0149	

# MAN

<b>572</b>	II <b>e1</b> 03★0031		ABS	Ø (18) / 22 / 28 mm
	II <b>(E1)</b> 020918			
	Beschreibung description descripção descrizione description benamning Popis описання özellik leirás opis		OE	
51.5720.120H		426 x 200 x 135	85.63730-6030	
40.5725.212H		412 x 188 x 3	81.63733-0101	
51.5720.140H		426 x 200 x 135	85.63730-6033	
40.5725.412H		412 x 188 x 3	81.63733-0103	
51.5721.160H		426 x 200 x 135	85.63730-6035	
51.5722.160H		426 x 200 x 135	85.63730-6036	
40.5725.412H		412 x 188 x 3	81.63733-0103	
61.5721.004.099		78 x 69 x 38		
11.5721.001.099		426 x 199 x 36		
11.3860.700		100 x 22 Ø → 18 Ø		

06/2005 →  
06/2005 →

TGL, TGM (TGA)  
L 2000, M 2000



MAN

<b>573</b>	IV <b>e1</b> 03★0032		ABS	Ø (18) / 22 / 28 mm
	IV <b>(E1)</b> 020917			
	Beschreibung description descripção descrizione description benamning Popis описання özellik leirás opis		OE	
56.5730.120H		202 x 198 x 126	85.63730-6037	
40.5735.203H		190 x 184 x 3	81.63733-0104	
56.5730.140H		202 x 198 x 126	85.63730-6039	
40.5735.403H		190 x 184 x 3	81.63733-0106	
61.5721.004.099		78 x 69 x 38		
11.5731.001.099		202 x 198 x 27		
11.3860.700		100 x 22 Ø → 18 Ø		





















<b>579</b>	V <b>e1</b> 03★0109		ABS	
	V <b>(E1)</b> 021179			
	Beschreibung description descripção descrizione description benamning Popis описання özellik leirás opis		OE	
56.5790.003.099		303 x 163 x 88	81.63730-6734 + 81.63730-6574	
15.5791.570.099		303 x 163 x 55	81.63733-6078	
56.5790.004.099		303 x 163 x 88	81.63730-6733+ 81.63730-6573	
15.5791.470H		303 x 163 x 55	81.63733-6074	















F 2000, L 2000  
M 2000

09/94 - 03/00  
09/97 - 03/00

# MAN











373	II  02★0524 II  010524	 	Ø (18) / 22 mm
	Beschreibung description descripción descrizione benamning popis omkažuje üzellik leiras opis		OE
51.3735.121H		384 x 205 x 120	81.63730-6314 + 81.63730-6331
51.3736.121H		384 x 205 x 120	81.63730-6303 + 81.63730-6332
51.3735.124H		384 x 205 x 120	81.63730-6315 + 81.63730-6365 81.63730-6361
51.3736.124H		384 x 205 x 120	81.63730-6304 + 81.63730-6366 81.63730-6362 + 81.63732-0046
51.3731.325		384 x 205 x 120	
51.3732.325		384 x 205 x 120	
51.3735.126H		384 x 205 x 120	81.63730-6316 + 81.63730-6367 81.63730-6363 + 81.63732-0051
51.3736.126H		384 x 205 x 120	81.63730-6305 + 81.63730-6368 81.63730-6364 + 81.63732-0047
15.3731.070H		369 x 190 x 42	81.63733-0066 + 81.63730-0066
15.3731.373		369 x 190 x 42	
15.3731.074H		369 x 190 x 42	81.63733-0067 + 81.63733-0075 81.63730-0067
11.3730.310H		367 x 187 x 60	
11.3860.700		100 x 22 ø -> 18 ø	













386	IV  02★0424 IV  010424	 	Ø (18) / 22 mm
	Beschreibung description descripción descrizione benamning popis omkažuje üzellik leiras opis		OE
56.3860.112H		219 x 170 x 120	81.63730-6306
56.3860.114H		219 x 170 x 120	81.63730-6307 + 81.63732-0050
56.3861.116H		219 x 170 x 120	81.63730-6317 + 81.63732-0049
56.3862.116H		219 x 170 x 120	81.63730-6308 + 81.63730-6328 81.63732-0048
11.3860.300H		203 x 154 x 60	
11.3860.700		100 x 22 ø -> 18 ø	



# MAN

380-1	II  03★0022 II  020905	 	Ø (18) / 22 mm
MEKRA LANG Group		mm	
Beschreibung description descripção descrizione benamining Popis описання özellik leirás opis		OE	
51.3801.148H	 24V	384 x 205 x 120	82.63730-6015
51.3802.148H	 24V	384 x 205 x 120	82.63730-6016
51.3801.168H	 24V	384 x 205 x 120	82.63730-6017
51.3802.168H	 24V	384 x 205 x 120	82.63730-6018
15.3802.840H	 1200 24V	368 x 189 x 40	81.63733-0095
11.3800.300H		374 x 196 x 40	81.63732-0044
11.3860.700		100 x 22 Ø -> 18 Ø	

381-1	IV  03★0023 IV  021248	 	Ø (18) / 22 mm
MEKRA LANG Group		mm	
Beschreibung description descripção descrizione benamining Popis описання özellik leirás opis		OE	
56.3812.128H		219 x 170 x 120	82.63730-6022 * 82.63730-6021
56.3812.148H	 24V	219 x 170 x 120	82.63730-6024 * 82.63730-6023
56.3811.168H	 24V	219 x 170 x 120	82.63730-6025
56.3812.168H	 24V	219 x 170 x 120	82.63730-6026
15.3811.870H	 300 24V	203 x 154 x 36	81.63733-0097 * 81.63733-0098
11.3810.340		209 x 160 x 40	81.63732-0078 * 81.63732-0045
11.3860.700		100 x 22 Ø -> 18 Ø	

New Regulation  
F 2000, L 2000  
M 2000  
2003/97/ECE  
2007/38/ECE  
09/94 - 03/00  
09/97 - 03/00



MAN



# MAN

F2000  
TGA  
TGL  
TGM

09/94 - 03/00  
03/00 →  
2005 - 11/14  
04/06 - 11/14



<b>579</b>	V e1 03★0109 V (E1) 021179			
	Beschreibung description descripção descripzióne descripcjón benamning popis opis opis opis		mm	OE
56.5790.003.099		303 x 163 x 88	81.63730-6734 + 81.63730-6574	
15.5791.570.099		303 x 163 x 55	81.63733-6078	
56.5790.004.099		303 x 163 x 88	81.63730-6733+ 81.63730-6573	
15.5791.470H		303 x 163 x 55	81.63733-6074	

TGA  
TGL  
TGM

03/00 - 11/06  
2005 - 11/06  
04/06 - 11/06



















<b>392</b>	II e1 02★0646 II (E1) 010646			Ø 28 mm
	Beschreibung description descripção descripzióne descripcjón benamning popis opis opis opis		mm	OE
51.3921.222H		399 x 207 x 137	81.63730-6395 + 81.63730-6345 81.63730-6430	
15.3921.870H		379 x 176 x 47	81.63733-0082 + 81.63733-6033	
51.3922.222H		399 x 222 x 138	81.63730-6399 + 81.63730-6347 81.63730-6432	
15.3922.870H		379 x 176 x 47	81.63733-0083 + 81.63733-6034	
11.3920.300H		57 x 23 x 30	81.63731-0286	
04.0603.007.000		30 x 6 Ø		
11.3921.110H		399 x 196 x 52	81.63732-0054 + 81.63732-0059 81.63732-0063	
11.3921.120H		399 x 210 x 52	81.63732-0055 + 81.63732-0060 81.63732-0064	













# MAN

<b>392-1</b>	II <b>e1</b> 03★0024 II <b>(E1)</b> 02 0925	 <b>II</b>	<b>ABS</b>	Ø 28 mm
--------------	--	---	------------	---------

		Beschreibung description description descricao descrizio benamining popis opisaniye özelliik leirás opís	mm	OE
51.3921.224H		399 x 207 x 137	81.63730-6482	
51.3923.224H		339 x 222 x 138	81.63730-6487	
51.3921.223H		399 x 207 x 137	81.63730-6480	
51.3923.223D		399 x 222 x 138	81.63730-6485	
15.3920.840H		379 x 176 x 47	81.63733-6049	
51.3922.224H		399 x 222 x 138	81.63730-6483	
51.3924.224H		399 x 207 x 137	81.63730-6486	
51.3922.223H		399 x 222 x 138	81.63730-6481	
51.3924.223D		399 x 207 x 137	81.63730-6484	
15.3920.840H		379 x 176 x 47	81.63733-6049	
11.3921.400		117 x 62 x 9	81.63731-0309 + 81.63731-0366	
04.0603.007.000		30 x 6 Ø		
11.3921.110H		399 x 196 x 52	81.63732-0054 + 81.63732-0059 81.63732-0063	
11.3921.120H		399 x 210 x 52	81.63732-0055 + 81.63732-0060 81.63732-0064	

<b>393-1</b>	IV <b>e1</b> 03★0025 IV <b>(E1)</b> 02 0924	 <b>IV</b>	<b>ABS</b>	Ø 28 mm
--------------	--	---	------------	---------

		Beschreibung description description descricao descrizio benamining popis opisaniye özelliik leirás opís	mm	OE
56.3931.343H		188 x 207 x 129	81.63730-6510	
56.3931.323H		188 x 207 x 129	81.63730-6512	
15.3932.870H		177 x 167 x 38	81.63733-6057	
56.3932.343H		188 x 220 x 130	81.63730-6511	
56.3932.323H		188 x 220 x 130	81.63730-6513	
15.3932.870H		177 x 167 x 38	81.63733-6057	
11.3921.400		117 x 62 x 9	81.63731-0309 + 81.63731-0366	
04.0603.007.000		30 x 6 Ø		
11.3931.110H		187 x 197 x 52	81.63732-0057 + 81.63732-0061 81.63732-0065	
11.3931.120H		187 x 209 x 52	81.63732-0056 + 81.63732-0062 81.63732-0066	

New Regulation  
2003/97/ECE  
TGA  
TGL  
TGM  
12/06 →  
12/06 - 11/14  
12/06 - 11/14



New Regulation  
2007/38/ECE  
TGA  
TGL  
TGM  
01/07 →  
12/06 - 11/14  
12/06 - 11/14



TGL Evolution  
TGM Evolution  
(Euro 6) 12/14  
(Euro 6) 12/14

# MAN

MAN



392-2		II [e1] 03★0024 II (E1) 02 0925	Truck II	ABS	Ø 28 mm
MEKRA LANG Group		Beschreibung description descripção descripziõe benájménng popis omicaawie čizellik leirás opis	mm		OE
51.3920.002.099		399 x 210 x 120	81.63730-6738		
51.3920.004.099		399 x 225 x 121	81.63730-6745		
51.3920.001.099		399 x 210 x 120	81.63730-6739		
51.3920.014.099		399 x 225 x 121	81.63730-6746		
51.3920.003.099		399 x 225 x 121	81.63730-6740		
51.3920.005.099		399 x 210 x 120	81.63730-6743		
51.3920.013.099		399 x 225 x 121	81.63730-6741		
51.3920.012.099		399 x 210 x 120	81.63730-6744		
19.3920.011.099		379 x 176 x 34	81.63733-6079		
12.3920.001.099		399 x 203 x 52	81.63732-0094		
12.3920.002.099		399 x 208 x 53	81.63732-0095		
11.3921.400		117 x 62 x 9	81.63731-0309 + 81.63731-0366		
04.0603.007.000		30 x 6 ø			

393-2		IV [e1] 03★0025 IV (E1) 02 0924	Truck IV	ABS	Ø 28 mm
MEKRA LANG Group		Beschreibung description descripção descripziõe benájménng popis omicaawie čizellik leirás opis	mm		OE
56.3930.004.099		187 x 210 x 127	81.63730-6748		
56.3930.002.099		187 x 210 x 127	81.63730-6749		
56.3930.003.099		188 x 223 x 128	81.63730-6750		
56.3930.001.099		188 x 223 x 128	81.63730-6751		
19.3930.311.099		177 x 167 x 35	81.63733-6080		
12.3930.001.099		187 x 197 x 52	81.63732-0096		
12.3930.002.099		187 x 209 x 52	81.63732-0097		
11.3921.400		117 x 62 x 9	81.63731-0309 + 81.63731-0366		
04.0603.007.000		30 x 6 ø			

579		V [e1] 03★0109 V (E1) 021179	Truck V	ABS	
MEKRA LANG Group		Beschreibung description descripção descripziõe benájménng popis omicaawie čizellik leirás opis	mm		OE
56.5790.002.099		303 x 163 x 88	81.63730-6735 + 81.63730-6578		
15.5791.570.099		303 x 163 x 55	81.63733-6078		

# MAN

<b>580</b>	II  03★0097			<b>INTEGR.</b>
	II  020929			
	IV  03★0098			
	IV  020930			

	Beschreibung description descripção description benámenning Popis описанье leírás opis		mm	

59.5800.101H		943 x 382 x 153	81.63730-6529	<b>TGX</b>
59.5800.102H		943 x 382 x 153	81.63730-6560 + 81.63730-6756	
59.5800.302H		943 x 382 x 153	81.63730-6563 + 81.63730-6767	
59.5800.201H		943 x 382 x 153	81.63730-6531	
59.5800.202H		943 x 382 x 153	81.63730-6561 + 81.63730-6765	
59.5800.203H		943 x 382 x 153	81.63730-6564 + 81.63730-6770	
59.5800.402H		943 x 382 x 153	81.63730-6562 + 81.63730-6758	

58.5800.101H		943 x 281 x 28 ø	81.63731-6638
58.5800.102H		943 x 281 x 28 ø	81.63731-6639

59.5800.121H		943 x 437 x 153	81.63730-6533	<b>TGS</b>
59.5800.122H		943 x 437 x 153	81.63730-6549 + 81.63730-6755	
59.5800.322H		943 x 437 x 153	81.63730-6552 + 81.63730-6764	
59.5800.221H		943 x 437 x 153	81.63730-6534	
59.5800.222H		943 x 437 x 153	81.63730-6550 + 81.63730-6762	
59.5800.223H		943 x 437 x 153	81.63730-6553 + 81.63730-6761	
59.5800.422H		943 x 437 x 153	81.63730-6551 + 81.63730-6757	

58.5800.201H		943 x 334 x 28 ø	81.63731-6640
58.5800.202H		943 x 334 x 28 ø	81.63731-6641

15.5801.840H		381 x 201 x 22	81.63733-6071	<b>a</b>
15.5811.871H		197 x 181 x 42	81.63733-6073	<b>b</b>
15.5811.872H		197 x 181 x 42	81.63733-6072	<b>c</b>

13.5800.100H		634 x 259 x 90	81.63732-0091
11.5800.100H		631 x 237 x 174	81.63731-0356
11.5800.200H		631 x 237 x 174	81.63731-0380

20.5800.410H		289 x 149 x 85	81.63732-0073
20.5800.420H		289 x 149 x 85	81.63732-0074
20.5800.610H		242 x 140 x 94	81.63732-0075
20.5800.620H		242 x 140 x 94	81.63732-0076
20.5800.710H		127 x 116 x 33	81.62410-0107
20.5800.720H		127 x 116 x 33	81.62410-0108
20.5800.750H		13 x 19 ø	81.63732-0090 + 81.62410-0109

<b>579</b>	V  03★0109			
	V  021179			

	Beschreibung description descripção description benámenning Popis описанье leírás opis		mm	

56.5790.002.099		303 x 163 x 88	81.63730-6735 + 81.63730-6578
15.5791.570.099		303 x 163 x 55	81.63733-6078

09/07 - 2021

TGX / TGS



MAN



01/2011

TGX / TGS



2020  
2020  
2020

TGX/TGS new  
TGL new  
TGM new

MAN



# MAN

**1024** **NEW** II (E1) 041543 IV (E1) 041542 **INTEGR.**









mm

	Beschreibung description descripção description benamning pops omicaame bœeilik lefrás opis					
<b>L H D</b>	59.1024.001.099		24 V	kurz short	936 x 355 x 206 81.63730-6859	
	59.1024.002.099		24 V	kurz short	936 x 355 x 206 81.63730-6860	
	59.1024.005.099		24 V	lang long	936 x 455 x 288 81.63730-6875	
	59.1024.006.099		24 V	lang long	936 x 455 x 288 81.63730-6874	
	59.1024.009.099		24 V	kurz short	936 x 355 x 206 81.63730-6853	
	59.1024.010.099		24 V	kurz short	936 x 355 x 206 81.63730-6854	
	59.1024.013.099		24 V	lang long	936 x 455 x 288 81.63730-6869	
	59.1024.014.099		24 V	lang long	936 x 455 x 288 81.63730-6868	
	59.1024.017.099		24 V	kurz short	936 x 355 x 206 81.63730-6865	
	59.1024.019.099		24 V	lang long	936 x 455 x 206 81.63730-6878	
	<b>R H D</b>	59.1024.021.099		24 V	kurz short	936 x 355 x 206 81.63730-6863
		59.1024.022.099		24 V	lang long	936 x 455 x 288 81.63730-6879
		59.1024.023.099		24 V	kurz short	936 x 355 x 206 81.63730-6861
		59.1024.024.099		24 V	kurz short	936 x 355 x 206 81.63730-6862
		59.1024.025.099		24 V	lang long	936 x 455 x 288 81.63730-6877
		59.1024.026.099		24 V	lang long	936 x 455 x 288 81.63730-6876
59.1024.027.099			24 V	kurz short	936 x 355 x 206 81.63730-6855	
59.1024.028.099			24 V	kurz short	936 x 355 x 206 81.63730-6856	
59.1024.029.099			24 V	lang long	936 x 455 x 288 81.63730-6871	
59.1024.030.099			24 V	lang long	936 x 455 x 288 81.63730-6870	
19.1024.011.099			24 V	<b>a</b>	379 x 193 x 35 81.63733-6083	
19.1024.012.099			24 V	<b>a</b>	379 x 193 x 35 81.63733-6084	
19.1024.311.099			24 V	<b>b</b>	204 x 196 x 51 81.63733-6085	
19.1024.312.099			24 V	<b>b</b>	204 x 196 x 51 81.63733-6086	
13.1024.001.099				427 x 244 x 122 81.63732-0111		
13.1024.002.099				427 x 244 x 122 81.63732-0110		
13.1024.003.099		paintable		427 x 244 x 122 81.63732-0125		
13.1024.004.099		paintable		427 x 244 x 122 81.63732-0124		
12.1024.009.099		für pour	foot cover top	241 x 137 x 105 81.63732-0115		
12.1024.010.099		für pour	foot cover top	241 x 137 x 105 81.63732-0114		
12.1024.011.099		für pour	foot cover bottom	215 x 148 x 100 81.63732-0113		
12.1024.012.099		für pour	foot cover bottom	215 x 148 x 100 81.63732-0112		

# MAN

**1020** **NEW** V (E1) 041389   **INTEGR.**

 *Beschreibung description descrição descriçõe descripcón benámining pppis omycauwe özeilikt leirát opís*  **OE**



56.1020.017.099		<b>LIN-BUS</b>	307 x 279 x 95	81.63730-6845
56.1020.018.099		<b>LIN-BUS</b>	307 x 279 x 95	81.63730-6846
56.1020.019.099		<b>CAN-BUS</b>	307 x 279 x 95	81.63730-6844
56.1020.020.099			307 x 279 x 95	81.63730-6843
56.1020.015.099			307 x 279 x 95	81.63730-6881
19.1020.213.099			297 x 172 x 62	81.63733-6087
19.1020.613.099			297 x 172 x 62	81.63733-6088
12.1020.003.099			191 x 137 x 41	81.63732-0106

MAN TGX/TGS



MAN

2017

**1013** **NEW** II (E1) 041427   **INTEGR.**

 *Beschreibung description descrição descriçõe descripcón benámining pppis omycauwe özeilikt leirát opís*  **OE**

19.1013.011.099			<b>a</b>	211 x 169 x 19	MAN 65.63733-0002 MAN 65.63733-0015
19.1013.012.099			<b>b</b>	211 x 169 x 19	MAN 65.63733-0006 MAN 65.63733-0014

TGE

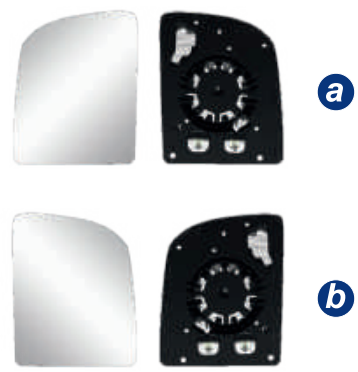

# MAN

276

II 02★0524 II 02★0423  
 II 010524 II 010423  
 II 03★0022 II 03★0088  
 II 020905 II 020923



Beschreibung  
 description  
 descripción  
 descrizione  
 descripción  
 benaming  
 popis  
 omicaame  
 ბეჩილ  
 opis



1	59.2762.101		592 x 205 x 120	
	51.3732.326		384 x 205 x 116	81.63730-6374 + 81.63730-6390
	15.3731.470H		369 x 190 x 42	81.63733-6029 + 81.63733-0075
	11.3730.210H		367 x 187 x 60	81.63732-0058
2	59.2762.322		592 x 205 x 120	
	51.3732.326		384 x 205 x 116	81.63730-6374 + 81.63730-6390
	15.3731.470H		369 x 190 x 42	81.63733-6029 + 81.63733-0075
	11.3730.210H		367 x 187 x 60	81.63732-0058
	59.2762.422		592 x 205 x 120	
	51.3731.326		384 x 205 x 116	81.63730-6375
	15.3731.470H		369 x 190 x 42	81.63733-6029 + 81.63733-0075
	11.3730.210H		367 x 187 x 60	81.63732-0058
	20.2710.620		124 x 59 x 21 [500]	36.63731-6000

271

II 02★0524  
 II 010524



Beschreibung  
 description  
 descripción  
 descrizione  
 descripción  
 benaming  
 popis  
 omicaame  
 ბეჩილ  
 opis



1	59.2712.111		783 x 703 x 212	83.63700-6502 + 81.63700-6091
	51.3731.326		384 x 205 x 116	81.63730-6375
	15.3731.470H		369 x 190 x 42	81.63733-6029 + 81.63733-0075
	15.2711.114		165 x 93 x 25	81.63733-6027
	11.3730.210H		367 x 187 x 60	81.63732-0058
	20.2700.200H		126 x 25 ø	
	20.2710.200H		183 x 181 x 84	81.63731-0289
	20.2480.216H		108 x 50 x 15 [2000]	83.63731-6507
2	59.2712.114		641 x 701 x 200	83.63700-6501 + 81.63700-6092
	51.3732.326		384 x 205 x 116	81.63730-6374 + 81.63730-6390
	15.3731.470H		369 x 190 x 42	81.63733-6029 + 81.63733-0075
	15.2711.114		165 x 93 x 25	81.63733-6027
	15.2712.114		152 x 128 x 23	81.63733-6028
	11.3730.210H		367 x 187 x 60	81.63732-0058
	20.2700.200H		126 x 25 ø	
	20.2710.200H		183 x 181 x 84	81.63731-0289
		20.2480.217H		108 x 50 x 15 [5000]

2002  
 2002  
 09/2012

Euroliner  
 Trendliner  
 PLAXTON: Elite



09/99  
 09/01  
 2002  
 2003

Intercity Mega S 2000  
 R07/08, A 20  
 Euroliner  
 Trendliner  
 Tourliner  
 Lions Coach Fortuna



# MAN

**278**

II 03★0128  
 II 020951  
 IV 03★0129  
 IV 020952

Beschreibung  
description  
descripção  
descripziune  
benamning  
popis  
описанье  
leírás  
opis

mm

OE

59.2780.130		684 x 247 x 174		<b>1</b>
59.2780.120.099		684 x 247 x 174	88.63700-6059	
59.2780.230		684 x 247 x 174		
59.2781.120		684 x 247 x 174		
59.2780.200.001		684 x 247 x 174		
59.2780.140.001		684 x 247 x 174	83.63700-6510	<b>2</b>
59.2780.150.001		684 x 247 x 174	83.63700-6511	
59.2780.180.001		684 x 247 x 174		
59.2780.160.001		684 x 247 x 174		
59.2780.170.001		684 x 247 x 174		
20.2710.620		124 x 59 x 21 [500]		
20.2710.650		124 x 59 x 21 [3500]		
08.3200.233H		42 x 42 x 54	81.25525-0232	
15.2780.840		307 x 177 x 22	81.63733-0113	
15.2780.841F		307 x 177 x 22		
15.2780.870		177 x 177 x 34	81.63733-0112	
15.2780.871F		177 x 177 x 34		
11.2780.910		681 x 229 x 104	81.63732-0088	
11.2780.920		681 x 229 x 104	36.63732-0006	
08.5752.012		130 x 120 x 53		
08.5752.024.099		130 x 120 x 53		

MAN Lion's City  
 MAN Lion's Regio  
 MAN Lion's Star  
 Inter Deck, IRISBUS (Citelis),  
 KRAVTEX, LAZ, SOLARIS (Urbino),  
 VDL (Citea), VOLVO 7900H,  
 Heuliez, Caetano, Plaxton, Scania  
 2007 →



1



2

MAN

# MAN

277	II e1 03★0084 II (E1) 020915	Truck II	ABS	INTEGR.
				
<div style="display: flex; justify-content: space-between;"> <span>Beschreibung description descripção descripziõe benamning popsis omrcauwe ürelilik teirras opis</span> <span>mm</span> <span>OE</span> </div>				
59.2770.210.099		1001 x 720 x 254	88.63700-6062	
59.2770.211.099		1001 x 720 x 254	88.63700-6066	
59.2771.210.099		1001 x 720 x 254	88.63700-6060	
59.2770.310.099		1001 x 720 x 254	2227 4292 (Volvo) 272 3896 (Scania)	
09.2770.210	(→ 59.2770.210.099)	6050 x 6 ø	88.25426-6837	
09.2770.211 + 09.2770.210	(→ 59.2770.211.099)	6050 x 6 ø	33.25404-6190 + 88.25426-6837	
09.2770.001.000	(→ 59.2771.210.099)	6050 x 6 ø		
08.2910.001.002	LED		33.25203-6001	
09.2910.003.099	(for LED )	6050 x 6 ø		
08.3200.233H		42 x 42 x 54	81.25525-0232	
08.2770.001.000		45 x 40 x 44	81.25505-6247	
08.3950.001.099	Control Unit (→ 59.2771.210.099)	40 x 30 x 30		
15.2771.840		307 x 183 x 23	81.63733-0110	
15.2771.870		206 x 166 x 37	81.63733-0111	
61.2770.210		670 x 280 x 253	81.63730-0083	
61.2772.211.099		670 x 280 x 253		
61.2770.211	(→ 59.2770.210.099 + 59.2770.211.099)	817 x 192 x 130	81.63731-0373	
11.2770.920		669 x 254 x 237	81.63732-0087	
11.2770.102	<b>1</b>	707 x 123 x 185	36.63732-0000	
11.2770.202	<b>2</b>	399 x 149 x 129	36.63732-0002	
11.2770.302	<b>3</b>	268 x 151 x 118	36.63732-0001	
11.2770.402	<b>4</b>	399 x 153 x 128	36.63732-0003	
61.2772.100	(for LED )	399 x 172 x 129	81.63732-0089	
08.5752.024.099		130 x 120 x 53	81.63734-6001	
61.2770.900.099	KIT 1		36.63732-6000	
61.2770.901.099	KIT 2			

MAN Lion's City  
MAN Lion's Regio  
MAN Lion's Star  
IRISBUS (Citelis), KRAVTEX, LAZ,  
VDL (Citea), VOLVO 7900H,  
Heuliez, Caetano, Plaxton, Scania  
2007

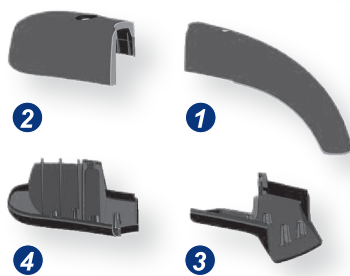

### KIT 1



Scharnierdeckel  
Hinge cover



Scharnierklemme  
Hinge clamp



Schenkeifeder  
Spring screw

### KIT 2



Spann Schlüssel  
Wrench



Spannhebel  
Bolt lever



Druckfeder  
Compression spring



# MAN

1041		II (E1) 041480		Truck II	ASA	INTEGR.
MEKRA LANG Group		Beschreibung description descripção descripção description benamining popis onircaune bűellik leirás opis		mm		OE
59.1041.001.099		636 x 907 x 250	36.63700-6018			
59.1041.002.099		636 x 907 x 250	33.63700-6004			
59.1041.003.099		636 x 907 x 250	83.63700-6530			
59.1041.004.001		636 x 907 x 250		5		
15.2780.840		178 x 307 x 22	36.63733-0011	a		
19.2910.002.099		172 x 184 x 39	36.63733-0010	b		
12.1041.001.099		274 x 643 x 165	36.63732-0037			
12.1041.002.099		114 x 313 x 63	36.63732-0035	1		
12.1041.003.099		112 x 194 x 91	36.63732-0034	2		
12.1041.004.099		113 x 349 x 75	36.63732-0033	3		
12.1041.005.099		90 x 470 x 118	36.63732-0036	4		
08.1024.124.099		120 x 130 x 45 mm	81.63734-6006 3139595 (Scania)	a		
09.1041.002.099		2400	36.25404-6033	a		
09.1041.004.099		2400	33.28104-6355	b		

2019 →  
Stadtbusse MAN  
(Lion's City)



5 Unter 2 m verbaubar und abklappbar  
Can be installed and folded away below 2 meters



2019 →

Stadtbusse MAN  
(Lion's City)

1042		II (E1) 041481 IV (E1) 041482		Truck II + IV	ASA	INTEGR.
MEKRA LANG Group		Beschreibung description descripção descripção description benamining popis onircaune bűellik leirás opis		mm		OE
59.1042.001.099		685 x 176 x 237	36.63700-6017			1
59.1042.002.099		685 x 176 x 237	36.63700-6022			
59.1042.004.099		685 x 176 x 237	36.63700-6020			
59.1042.005.099		685 x 176 x 237	33.63700-6003			
59.1042.003.099		685 x 176 x 237	36.63700-6019			2
15.2780.840		178 x 307 x 22	36.63733-0011	a		
19.2910.001.099		154 x 183 x 31	36.63733-0010	b		
12.1042.001.099		232 x 528 x 87	36.63732-0040			
12.1042.002.099		232 x 528 x 87	36.63732-0041			
61.1042.005.099		127 x 172 x 111			for door	
61.1042.006.099		167 x 160 x 163			for A-Pillar	
08.1024.124.099		120 x 130 x 45 mm	81.63734-6006 3139595 (Scania)	a		
20.1042.002.099		2100	36.63731-6012			
20.1042.003.099		2500	36.63731-6013			
09.1041.004.099		2400	33.28104-6355	b		



# MERCEDES

<b>253</b>	II e1 02★14067 II (E1) 0114067			Ø 18 mm
------------	-----------------------------------	--	--	---------

	Beschreibung description description description benamning popis omircaune üzeylik leirás opis		OE
--	---	--	----

51.2530.120H		370 x 182 x 64	381 810 25 16 + 000 810 27 16 281 810 71 16 + 000 810 62 16 000 811 12 33 + 314 810 26 16 381 810 71 16 + 663 810 08 16 673 810 08 16 + 673 810 40 16 000 811 33 33 + 001 811 87 33 000 811 20 33 + 000 811 64 33 000 811 21 33
40.2530.222H		356 x 170 x 3	000 811 33 33 + 001 811 87 33 000 811 20 33 + 000 811 64 33 000 811 21 33
61.2530.110H		55 x 43 x 36	000 811 02 39
51.2530.140H		370 x 182 x 64	381 810 73 16 + 381 810 26 16 000 810 23 16 + 301 810 21 16 314 810 26 16 + 673 810 42 16
40.2530.422H		356 x 170 x 3	
09.2070.101H		2070 x 9 ø	000 150 55 33
61.2530.110H		55 x 43 x 36	000 811 02 39

1013 - 2644  
EvoBus D 303, 404, 405, 407  
08/73 - 12/86



MERCEDES

<b>254</b>	II e1 01★14068			Ø 18 mm
------------	----------------	--	--	---------

	Beschreibung description description description benamning popis omircaune üzeylik leirás opis		OE
--	---	--	----

51.2540.120H		305 x 183 x 60	314 810 13 16 + 000 810 04 16 000 810 48 16 + 673 810 39 16 000 811 35 33 + 001 811 90 33 000 811 19 33
40.2540.222H		291 x 170 x 3	000 811 35 33 + 001 811 90 33 000 811 19 33
61.2530.110H		55 x 43 x 36	000 811 02 39
51.2540.130H		305 x 183 x 60	314 810 19 16 + 000 810 06 16 000 810 20 16
40.2540.222H		291 x 170 x 3	000 811 35 33 + 001 811 90 33 000 811 19 33
09.2070.101H		2070 x 9 ø	000 150 55 33
61.2530.110H		55 x 43 x 36	000 811 02 39
51.2540.140H		305 x 183 x 60	314 810 20 16 + 673 810 41 16
40.2540.422H		291 x 170 x 3	001 811 90 33 + 000 821 08 29
09.2070.101H		2070 x 9 ø	000 150 55 33
61.2530.110H		55 x 43 x 36	000 811 02 39

LK08 - 1113  
LN2 (LK)  
11/77  
12/98



# MERCEDES

<b>375</b>	II  03★0123 II  020941 II  02★0505 II  010505			Ø 28 mm
------------	--	--	--	---------

		Beschreibung description descripción descrizione benámining popis onircaawne breiðlik leirfás opis		OE
61.3752.147H		380 x 170 x 68	000 810 02 79	
15.3752.470H		380 x 170 x 15	001 811 34 33 + 001 811 73 33	
61.3780.100H		74 x 65 x 14	000 811 13 07	
61.3752.167H		380 x 170 x 68	000 810 03 79	
15.3752.470H		380 x 170 x 15	001 811 34 33 + 001 811 73 33	
61.3780.100H		74 x 65 x 14	000 811 13 07	



Atego (LKN)  
Axor  
Unimog U 20

MERCEDES

<b>377</b> <b>377-1</b>	IV  02★0462 IV  010462 IV  03★0019			Ø 28 mm
----------------------------	--	--	--	---------

		Beschreibung description descripción descrizione benámining popis onircaawne breiðlik leirfás opis		OE
61.3770.147H		200 x 200 x 155	000 810 96 16 + 001 811 21 33 + 000 811 13 07	
15.3774.410H		200 x 200 x 15	001 811 21 33	
61.3772.147H		200 x 200 x 118	000 810 96 16	
61.3780.100H		74 x 65 x 14	000 811 13 07	
61.3773.147H		200 x 200 x 155	001 810 92 16 + 000 811 13 07	
15.3771.174H		200 x 200 x 15	001 811 60 33	
61.3780.100H		74 x 65 x 14	000 811 13 07	



Atego (LKN)  
Axor

<b>375 A</b>			Ø 28 mm
--------------	--	--	---------

		Beschreibung description descripción descrizione benámining popis onircaawne breiðlik leirfás opis		OE
58.3752.100		639 x 325 x 28 ø	973 810 03 14	
58.3752.200		639 x 325 x 28 ø	973 810 04 14	
20.3750.710.099		136 x 82 x 73	000 811 03 61	
20.3750.720.099		136 x 82 x 73	000 811 04 61	

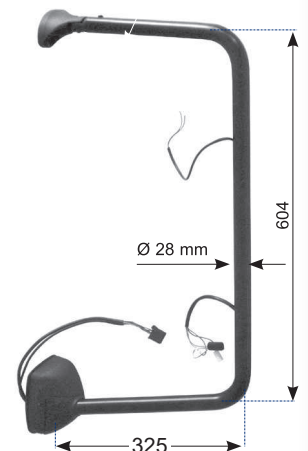

Atego (LKN)  
Axor

# MERCEDES

Atego II (LKN)  
Axor II



10/04  
10/04

575	II (E1) 021144		ABS	Ø 28 mm	
MEKRA LANG Group		Beschreibung description descripción descripcióe benamining popis omicaawe üzeylik leirás opis		mm	OE
51.5750.003.099		439 x 219 x 124	000 810 17 79 + 000 810 22 79		
51.5750.004.099		439 x 219 x 124	000 810 14 79 + 000 810 23 79		
09.5750.220.099		250	000 820 28 13		
51.5750.001.099		439 x 219 x 124	000 810 18 79 + 000 810 20 79		
51.5750.002.099		439 x 219 x 124	000 810 15 79 + 000 810 21 79		
09.5750.001.099		335	000 820 27 13		
19.5750.011.099		435 x 196 x 39	002 811 46 33		
15.5750.840H		431 x 186 x 15	001 811 99 33		
61.5750.100H		86 x 79 x 77	000 811 20 07		



577	IV (E1) 021145		ABS	Ø 28 mm	
MEKRA LANG Group		Beschreibung description descripción descripcióe benamining popis omicaawe üzeylik leirás opis		mm	OE
51.5770.001.099		214 x 199 x 116	000 810 16 79 + 000 810 24 79		
19.5770.311.099		203 x 200 x 43	002 811 47 33		
15.5770.870H		192 x 186 x 15	002 811 00 33		
09.5750.220.099		250	000 820 28 13		
61.5750.100H		86 x 79 x 77	000 811 20 07		

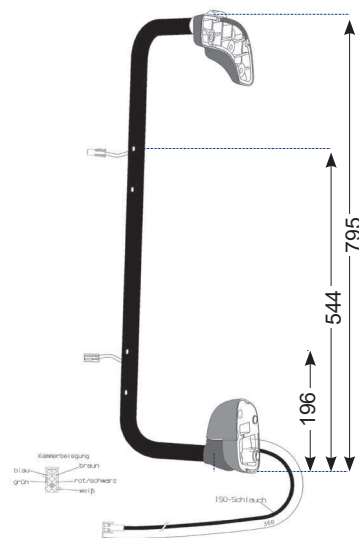

575 A			Ø 28 mm		
MEKRA LANG Group		Beschreibung description descripción descripcióe benamining popis omicaawe üzeylik leirás opis		mm	OE
58.5752.100H		795 x 321 x 28 ø	001 810 97 14		
58.5752.200H		795 x 376 x 28 ø	001 810 98 14		
58.5752.300H		795 x 376 x 28 ø	001 810 99 14		
58.5752.400E		795 x 321 x 28 ø	002 810 00 14		
58.5750.012.199		795 x 322 x 28 ø	002 810 85 14		
58.5750.005.199		795 x 322 x 28 ø	002 810 94 14		
20.5750.710.099		134 x 80 x 74	000 811 18 07		
20.5750.720.099		134 x 80 x 74	000 811 19 07		

# MERCEDES

<b>579</b>	V <span style="border: 1px solid black; padding: 2px;">e1</span> 03★0109 V <span style="border: 1px solid black; padding: 2px;">E1</span> 021179			
	Beschreibung description descripção descripziune benamning popis opisacune leírás opis			
56.5790.004.099		303 x 163 x 88	002 810 08 16	
15.5791.470H		303 x 163 x 55	002 811 22 33	

*Atego (LKN)  
Axor  
Atego II (LKN)  
Axor II*

*01/98 - 05/08  
09/01 - 09/04  
10/04 →  
10/04 →*



New Regulation ECE R46/04



MERCEDES

<b>1004</b>	V <span style="border: 1px solid black; padding: 2px;">E1</span> 04 1341			
	Beschreibung description descripção descripziune benamning popis opisacune leírás opis			
56.1004.001.099		338 x 275 x 105	002 810 60 16	

<b>396</b>	VI <span style="border: 1px solid black; padding: 2px;">e1</span> 03★0017			INTEGR.
	Beschreibung description descripção descripziune benamning popis opisacune leírás opis			
59.3962.210H		1261 x 303	973 810 73 16	
59.3964.210H		1145 x 265	940 810 55 16	
56.3960.148H		130 x 250 ø	000 810 08 79 + 001 811 69 33 + 000 811 13 07	
15.3961.174H		45 x 250 ø	001 811 69 33	
61.3780.100H		74 x 65 x 14	000 811 13 07	



# MERCEDES

<b>378</b> <b>378-1</b>	II [E1] 02★0463 II [E1] 010463 II [E1] 03★0018		Ø 28 mm
----------------------------	--	--	---------

	Beschreibung description descripção descrizione benamning poppis õnircaave breylik opis		mm	OE
--	---	--	----	----

61.3780.147H		433 x 188 x 85	 000 810 95 16 + 001 811 20 33 + 000 811 13 07
15.3784.470H		433 x 188 x 15	001 811 20 33
61.3782.147H		433 x 188 x 68	000 810 95 16
61.3780.100H		74 x 65 x 14	000 811 13 07
61.3783.147H		433 x 188 x 68	 001 810 90 16 + 000 811 13 07
15.3780.840H		433 x 188 x 15	002 811 04 33
61.3780.100H		74 x 65 x 14	000 811 13 07
61.3782.167H		433 x 188 x 68	000 810 94 16
15.3784.470H		433 x 188 x 15	001 811 20 33
61.3780.100H		74 x 65 x 14	000 811 13 07
61.3783.167H		433 x 188 x 68	 001 810 91 16 + 000 811 13 07
15.3780.840H		433 x 188 x 15	002 811 04 33
61.3780.100H		74 x 65 x 14	000 811 13 07

Actros (SKL) I+II  
Econic

09/96  
03/98



MERCEDES

<b>377</b> <b>377-1</b>	IV [E1] 02★0462 IV [E1] 010462 IV [E1] 03★0019		Ø 28 mm
----------------------------	--	--	---------

	Beschreibung description descripção descrizione benamning poppis õnircaave breylik opis		mm	OE
--	---	--	----	----

61.3770.147H		200 x 200 x 155	 000 810 96 16 + 001 811 21 33 + 000 811 13 07
15.3774.410H		200 x 200 x 15	001 811 21 33
61.3772.147H		200 x 200 x 118	000 810 96 16
61.3780.100H		74 x 65 x 14	000 811 13 07
61.3773.147H		200 x 200 x 155	 001 810 92 16 + 000 811 13 07
15.3771.174H		200 x 200 x 15	001 811 60 33
61.3780.100H		74 x 65 x 14	000 811 13 07

Actros (SKL) I+II  
Econic

09/96 - 05/08  
03/98

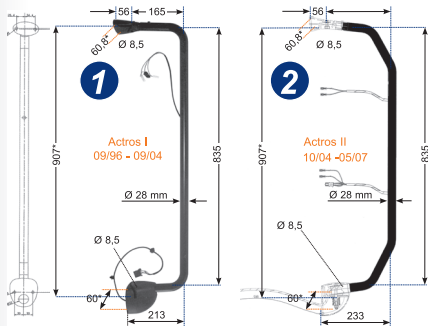

<b>378 A</b>			Ø 28 mm
--------------	--	--	---------

	Beschreibung description descripção descrizione benamning poppis õnircaave breylik opis		mm	OE
--	---	--	----	----

58.3781.100H		983 x 197 x 28 Ø	001 810 44 14
58.3781.200H		983 x 197 x 28 Ø	001 810 45 14
58.3783.300H		983 x 227 x 28 Ø	002 810 08 14
58.3783.200H		983 x 227 x 28 Ø	002 810 09 14
20.3780.700H		96 x 91 x 88	941 811 00 07

# MERCEDES

579	V <b>e1</b> 03★0109			
	V <b>(E1)</b> 021179			
	Beschreibung description descripção descripziune benamning popis opis opis			OE
56.5790.004.099		303 x 163 x 88	002 810 08 16	
15.5791.470H		303 x 163 x 55	002 811 22 33	

Actros (SKL) I+II  
Econic  
09/96 - 05/08  
03/98 →



1004	V <b>(E1)</b> 04 1341			
	Beschreibung description descripção descripziune benamning popis opis opis			OE
56.1004.001.099		338 x 275 x 105	002 810 60 16	

New Regulation ECE R46/04



MERCEDES

396	V <b>e1</b> 03★0017			INTEGR.
	Beschreibung description descripção descripziune benamning popis opis opis			OE
59.3965.210H		1219 x 303	943 810 47 16	
56.3960.148H		130 x 250 ø	000 810 08 79 + 001 811 69 33 + 000 811 13 07	
15.3961.174H		45 x 250 ø	001 811 69 33	
61.3780.100H		74 x 65 x 14	000 811 13 07	

Actros I + II



# MERCEDES

ACTROS MP3



<b>1012</b>	<b>ECE</b>	<b>II + IV</b> Truck		
<b>MEKRA LANG Group</b>	Beschreibung description descripção descripziune benamning popis opisacune özelliik leirás opis		mm	<b>OE</b>
19.1012.002.099		<b>1200</b>	<b>24 V</b>	<b>a</b> 401 x 200 x 55 002 811 33 33
19.1012.003.099		<b>1200</b>	<b>24 V</b>	<b>a</b> 401 x 200 x 55 002 811 34 33
19.1012.000.099		<b>300</b>	<b>24 V</b>	<b>b</b> 196 x 193 x 44 002 811 37 33
19.1012.001.099		<b>300</b>	<b>24 V</b>	<b>b</b> 196 x 193 x 44 002 811 38 33

MERCEDES

ACTROS MP4  
ANTOS  
AROCS  
(SFTP)



10/2011  
07/2012  
05/2013

<b>600</b>	<b>II (E1) 02★1112</b> <b>IV (E1) 02★1113</b>	<b>II + IV</b> Truck	<b>ABS</b>	<b>INTEGR.</b>
<b>MEKRA LANG Group</b>	Beschreibung description descripção descripziune benamning popis opisacune özelliik leirás opis		mm	<b>OE</b>
15.6000.001.099		<b>1200</b>	<b>24 V</b>	<b>a</b> 430 x 193 x 34 002 811 63 33
15.6000.002.099		<b>1200</b>	<b>24 V</b>	<b>a</b> 430 x 193 x 34 002 811 64 33
15.6000.003.099		<b>300</b>	<b>24 V</b>	<b>b</b> 204 x 236 x 51 002 811 65 33
15.6000.004.099		<b>300</b>	<b>24 V</b>	<b>b</b> 204 x 236 x 51 002 811 66 33

Komplettsystem (MP3 + MP4) bei Mercedes erhältlich  
complete system (MP3 + MP4) available at Mercedes

ACTROS MP3  
ACTROS MP4  
ANTOS  
AROCS  
(SFTP)



10/2011  
07/2012  
05/2013

<b>1004</b>	<b>V (E1) 04 1341</b>	<b>V</b> Truck	<b>ABS</b>	
<b>MEKRA LANG Group</b>	Beschreibung description descripção descripziune benamning popis opisacune özelliik leirás opis		mm	<b>OE</b>
56.1004.001.099				338 x 275 x 105 002 810 60 16

New Regulation ECE R46/04





## Electronics and Accessories

Product Catalog for Camera Monitor Systems and Active Alarm Systems

Download



# MERCEDES

1994 →  
EvoBus Kombibus  
Ares (Renault, Karosa, Iveco)



<b>281</b>	II E1 02★0447 II E1 010447 II E1 02★0448	Truck II	ABS	INTEGR.
	Beschreibung description descripção descripzione descripció benámenning popis omicawire özzeilikk leirás opis	mm	OE	
59.2810.111H		470 x 230 x 85		
59.2810.113H		470 x 230 x 85		
15.2810.480H		409 x 168 x 6		
11.2810.200H		460 x 180 x 50		

1999 →

Conecto C/Ü  
Intouro



<b>398</b>	II E1 03★0123 II E1 020941 II E1 02★0505 II E1 010505	Truck II	ABS	
	Beschreibung description descripção descripzione descripció benámenning popis omicawire özzeilikk leirás opis	mm	OE	
<b>1</b>	59.3980.021H		551 x 278 x 147	671 810 09 16
	59.3980.022H		551 x 1278 x 47	671 810 13 16
<b>2</b>	59.3980.121		435 x 246 x 143	628 810 30 16
	59.3980.122		435 x 246 x 143	628 810 31 16
<b>3</b>	59.3980.011H		474 x 733 x 166	671 810 07 16
	59.3980.012		474 x 733 x 166	671 810 12 16
	59.3980.111		474 x 733 x 166	628 810 33 16
	59.3980.112		474 x 733 x 166	628 810 34 16
<b>4</b>	59.3980.132		622 x 758 x 224	628 810 37 16
	59.3980.141		622 x 758 x 224	633 810 01 16
	59.3980.142		622 x 758 x 224	633 810 02 16
	61.3752.147H		380 x 170 x 68	000 810 02 79
	61.3752.167H		380 x 170 x 68	000 810 03 79
	15.3752.470H		380 x 170 x 15	001 811 34 33 + 001 811 73 33
	61.3773.147H		200 x 200 x 155	001 810 92 16
	15.3771.174H		200 x 200 x 15	001 811 60 33
	61.3780.100H		74 x 65 x 14	000 811 13 07
	20.2480.216H		108 x 50 x 15 [2000]	
	20.2480.217H		108 x 50 x 15 [5000]	

09/97 →  
10/03 →  
09/99 →  
09/97 →  
Travego  
Tourino  
Setra TC 400  
Multegeo  
Tourismo



<b>395</b>	II E1 02★0620 II E1 020926 II E1 010620 V E1 03★0174 II E1 03★0047 V E1 020998	II + V		
	Beschreibung description descripção descripzione descripció benámenning popis omicawire özzeilikk leirás opis	mm	OE	
	15.3951.174		a	368 x 174 x 15 629 811 00 33
	15.3952.174		a	368 x 174 x 15 629 811 02 33
	15.3951.114		b	202 x 153 x 15 629 811 01 33

# MERCEDES

<b>249 K</b>	III e1 01★17023		PP	① Ø 10 mm ② Ø 12 mm
Beschreibung description description descripção descrizione benamining popis описување beležik leirás opis				OE
51.2491.121H		①	210 x 140 x 21	460 810 01 16 + 601 810 02 16 460 810 03 16
51.2491.122H		②	210 x 140 x 21	601 810 01 16

<b>249 L</b>	II e1 02★14035 II (E1) 0114035		PP	① Ø 10 mm ② Ø 14 - 20 mm
Beschreibung description description descripção descrizione benamining popis описување beležik leirás opis				OE
51.2493.121H		①	247 x 157 x 61	612 810 01 66 + 611 810 01 16
51.2493.127H		②	247 x 157 x 61	

<b>349 349 TW</b>	II e1 02★0384 II (E) 010384 II e1 02★0418 II (E) 010418		ABS	① INTEGR. ③ Ø 18 mm
Beschreibung description description descripção descrizione benamining popis описување beležik leirás opis				OE
51.3490.110H		①	283 x 295 x 80	901 810 01 16 + 901 810 55 16
15.3491.071H			238 x 142 x 6	001 811 06 33
51.3490.120H		①	283 x 340 x 80	901 810 02 16 + 901 810 64 16
15.3491.072H			238 x 142 x 6	001 811 07 33
51.3490.112H		①	283 x 295 x 80	901 810 09 16 + 901 810 57 16
15.3491.371H			238 x 142 x 6	001 811 05 33
51.3490.122H		①	283 x 340 x 80	901 810 10 16 + 901 810 66 16
15.3491.372H			238 x 142 x 6	001 811 04 33
56.3491.110H		②	175 x 116 x 70	901 810 10 93 + B 66 5603 97
15.2711.214H			165 x 93 x 15	
56.3492.110H		②	175 x 116 x 70	901 810 11 93 + B 66 5603 98
15.2711.214H			165 x 93 x 15	
59.3491.110H		③	283 x 495 x 80	901 810 25 16 + 901 810 58 16
59.3492.110H			283 x 465 x 80	901 810 37 16 + 901 810 61 16
15.3491.071H			238 x 142 x 6	001 811 06 33
59.3491.120H		③	283 x 535 x 80	901 810 26 16 + 901 810 67 16
59.3492.120H			283 x 535 x 80	901 810 38 16 + 901 810 70 16
15.3491.072H			238 x 142 x 6	001 811 07 33

05/77 - 07/81  
05/79 →

Transporter  
207D - 308 (T1, TN)  
Typ 230 GE, 280 GE  
Typ 240 GD, 300 GD



08/81 - 02/95

Transporter  
207D - 410 (T1, TN)



01/95 - 09/95

Sprinter (T1N)

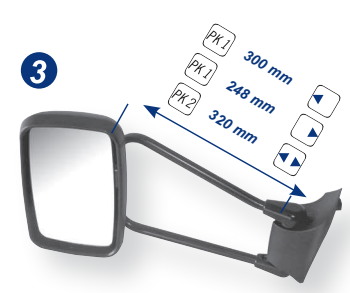



# MERCEDES

589	II III e1 03★0006	
	II III E1 020902	

	Beschreibung description descripção descrizione description benamning Pops omicaawke betrials opts	mm	OE
15.5891.741H		236 x 155 x 16	002 811 15 33
15.5891.742H		236 x 155 x 16	002 811 16 33
15.5891.611H		154 x 59 x 19	002 811 19 33
15.5891.612H		154 x 59 x 19	002 811 20 33
19.5890.011.099		240 x 158 x 21	002 811 52 33
19.5890.012.099		240 x 158 x 21	002 811 53 33
19.5891.011.099		240 x 158 x 21	002 811 56 33
19.5891.012.099		240 x 158 x 21	002 811 57 33
08.5890.300.099		113 x 32 x 15	000 440 00 15
08.5890.301.099		113 x 32 x 15	000 440 01 15
15.5891.721.099		157 x 65 x 20	002 811 39 33
15.5891.722.099		157 x 65 x 20	002 811 40 33
13.5890.110.199		344 x 218 x 82	000 811 10 22
13.5890.210.199		344 x 218 x 82	000 811 11 22
13.5890.120.099		344 x 201 x 82	001 811 00 22
13.5890.220.099		344 x 201 x 82	001 811 01 22
14.5890.100.099		337 x 192 x 56	000 813 04 36
14.5890.200.099		337 x 192 x 56	000 813 05 36
08.5892.001.099		13 133 x 118 x 88	001 822 89 20 + 000 820 12 77
08.5892.002.099		13 133 x 118 x 88	001 822 93 20 + 000 820 12 77
08.5892.003.099		13 133 x 118 x 88	001 822 90 20 + 000 820 12 77
08.5892.004.099		13 133 x 118 x 88	001 822 92 20 + 000 820 12 77
08.5892.105.099		12 51 x 27 ø	000 820 12 77

Mercedes Sprinter II (NCV3) 10/05 - 09/10



MERCEDES

Sprinter II Euro 5 + 6 10/2010 - 11/2017



ab Fahrgestellnr. starting with chassis no. 906 155 1 N 463 439



ab Fahrgestellnr. starting with chassis no. 906 155 1 N 416 545



2018

# MERCEDES

1039

**NEW**

II (E1) 041469



ABS

INTEGR.



Beschreibung  
description  
description  
descripção  
description  
benamning  
pops  
ömrcauwe  
bueilikk  
reirás  
opis



OE

Sprinter III  
W907 und W910

MERCEDES



L  
H  
D

R  
H  
D



Part No.	Icons	Dimensions	OE No.
59.1039.125.099	[Icons]	423 x 280 x 160	9108100300
59.1039.225.099	[Icons]	423 x 280 x 160	9108100400
59.1039.101.099	[Icons]	423 x 280 x 160	9108108901
59.1039.201.099	[Icons]	423 x 280 x 160	9108109001
59.1039.104.099	[Icons]	423 x 280 x 160	9108101100
59.1039.204.099	[Icons]	423 x 280 x 160	9108101200
59.1039.105.099	[Icons]	423 x 280 x 160	9108101900
59.1039.205.099	[Icons]	423 x 280 x 160	9108102000
59.1039.175.099	[Icons]	423 x 280 x 160	9108100500
59.1039.275.099	[Icons]	423 x 280 x 160	9108100600
59.1039.151.099	[Icons]	423 x 280 x 160	9108109101
59.1039.251.099	[Icons]	423 x 280 x 160	9108109201
59.1039.158.099	[Icons]	423 x 280 x 160	9108109501
59.1039.258.099	[Icons]	423 x 280 x 160	9108109601
59.1039.154.099	[Icons]	423 x 280 x 160	9108101300
59.1039.254.099	[Icons]	423 x 280 x 160	9108101400
59.1039.155.099	[Icons]	423 x 280 x 160	9108102100
59.1039.255.099	[Icons]	423 x 280 x 160	9108102200
19.1039.411.099	[Icons]	207 x 139 x 20	9108112500
19.1039.412.099	[Icons]	207 x 139 x 20	9108112400
19.1039.011.099	[Icons]	207 x 139 x 20	9108112700
19.1039.012.099	[Icons]	207 x 139 x 20	9108112600
19.1039.811.099	[Icons]	207 x 139 x 20	9108112900
19.1039.812.099	[Icons]	207 x 139 x 20	9108112800
19.1039.311.099	[Icons]	137 x 70 x 20	9108113700
19.1039.312.099	[Icons]	137 x 70 x 20	9108113600
13.1039.001.099	[Icons]	308 x 216 x 104	9108114100
13.1039.002.099	[Icons]	308 x 216 x 104	9108114000
11.1039.011.099	[Icons]	308 x 189 x 60	9108113900
11.1039.012.099	[Icons]	308 x 189 x 60	9108113800
08.1039.011.099	[Icons]	Ø 38 x 15	9109065600
61.1039.002.099	[Icons]	Ø 36 x 19	9108250400
08.1039.001.099	[Icons]	87 x 67 x 54	9109064700
08.1039.002.099	[Icons]	87 x 67 x 54	9109064600
11.1039.001.099	[Icons]	62 x 87 x 27	9108114500
11.1039.002.099	[Icons]	62 x 87 x 27	9108114400
08.1039.005.099	[Icons]	35 x 42 x 12	9105420100
08.1039.006.099	[Icons]	35 x 42 x 12	9105420000



# RENAULT

**390** II 03★0009  
 II 020914  
 IV 03★0037  
 IV 020916

**INTEGR.**

**MEKRA LANG Group**

Beschreibung description descrição descrição descrição benámining popis omivcawne бейлік тейлэс opis

mm

**OE**

59.3900.143H		880 x 340 x 155	50.10.623.231
59.3900.243H		880 x 340 x 155	50.10.623.232 + 74.21.326.527
59.3900.133H		880 x 440 x 155	50.10.623.246
59.3900.233H		880 x 440 x 155	50.10.623.247 + 74.21.326.526
59.3900.343		880 x 340 x 155	
59.3900.443		880 x 340 x 155	
59.3900.333		880 x 440 x 155	
59.3900.433		880 x 440 x 155	
15.3900.840H		337 x 202 x 25	74.20.862.795
15.3911.871H		200 x 197 x 75	74.20.862.810
15.3911.872H		200 x 197 x 75	74.20.862.815
61.3900.100H		373 x 245 x 101	74.20.862.782
61.3900.110H		373 x 245 x 101	74.20.866.665
61.3900.120H		373 x 245 x 101	74.20.913.815 + 74.85.120.820
61.3900.130H		373 x 245 x 101	74.85.120.820
61.3911.110H		245 x 236 x 105	74.20.862.809
61.3911.120H		245 x 236 x 105	74.20.862.813
11.3900.200H		371 x 244 x 80	74.20.862.779
11.3910.200H		244 x 225 x 75	74.20.862.800
08.5752.024.099		130 x 120 x 53	74.20.866.672 + 74.20.862.812 74.21.618.499
09.3900.003.000		300 x 6 ø	74.21.614.025
20.3900.510H		518 x 160 x 98	50.10.623.057
20.3900.520H		518 x 160 x 98	50.10.623.058

Midlum 1818  
 Premium Distribution  
 Kerax  
 D-Serie  
 C-Serie (2,3 m)

05/06 - 09/13  
 05/06 - 09/13  
 05/06 - 09/13  
 10/13  
 10/13

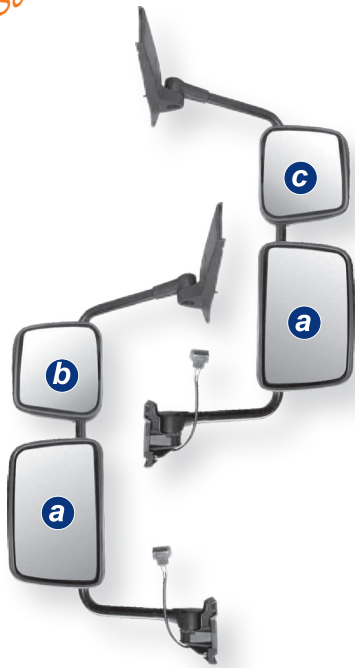

RENAULT



# RENAULT

<b>390</b>	II [e1] 03★0009		ABS	INTEGR.
	II [e1] 020914			
	IV [e1] 03★0010			
	IV [e1] 020913			

MEKRA LANG Group	Beschreibung / description / descrição / descrizione / benámining / popis / опис / özeilik / leirás / opis						mm	OE
	Icons	Icons	Icons	Icons	Icons	Icons		
59.3900.123H							880 x 340 x 155	50.10.578.503
59.3900.223H							880 x 340 x 155	50.10.578.504 + 74.21.326.550
59.3900.323							880 x 340 x 155	
59.3900.423H							880 x 340 x 155	
15.3900.840H							337 x 202 x 25	74.20.862.795
15.3910.871H							203 x 189 x 75	74.20.903.745
15.3910.872H							203 x 189 x 75	74.20.903.746
61.3900.100H							373 x 245 x 101	74.20.862.782
61.3900.110H							373 x 245 x 101	74.20.866.665
61.3900.120H							373 x 245 x 101	74.20.913.815 + 74.85.120.820
61.3900.130H							373 x 245 x 101	74.85.120.820
61.3910.110H							300 x 230 x 105	74.20.904.268
61.3910.120H							300 x 230 x 105	74.20.904.269
11.3900.100H							371 x 244 x 80	74.20.903.880
11.3910.110H							303 x 244 x 75	74.20.903.882
11.3910.120H							303 x 244 x 75	74.20.903.883
08.5752.024.099							130 x 120 x 53	74.20.866.672 + 74.20.862.812 74.21.618.499
09.3900.003.000							300 x 6 ø	74.21.614.025
20.3900.510H							518 x 160 x 98	50.10.623.057
20.3900.520H							518 x 160 x 98	50.10.623.058

<b>552-1</b>	V VI [e1] 03★0033		ABS	INTEGR.
	V VI [E1] 020894			

MEKRA LANG Group	Beschreibung / description / descrição / descrizione / benámining / popis / опис / özeilik / leirás / opis						mm	OE
	Icons	Icons	Icons	Icons	Icons	Icons		
59.5524.648.099							725 x 319 x 126	74.20.849.837 + 74.82.226.025
51.5524.930H							316 x 186 x 77	74.21.020.285
59.5524.649.099							437 x 319 x 103	74.20.849.835 + 74.82.226.027
51.5524.930H							316 x 186 x 77	74.21.020.285

Premium Route 2711 10/05 - 09/13

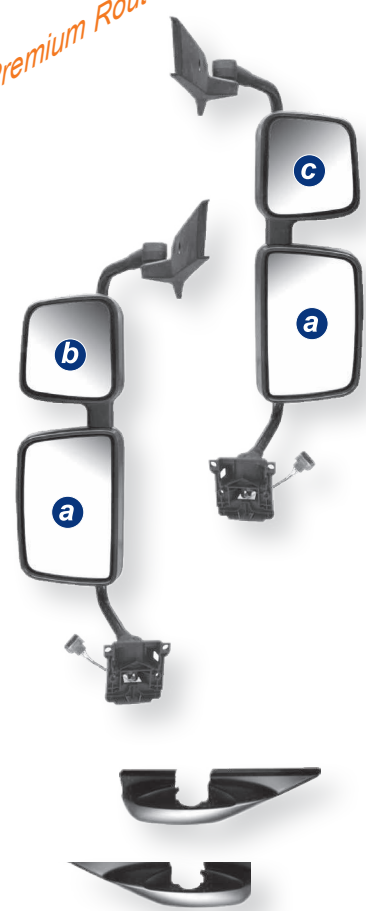

RENAULT

Premium Route 2711 10/05 - 09/13  
 Midlum 1818 05/06 - 09/13  
 Premium Distribution 05/06 - 09/13  
 Kerax 10/13  
 D-Serie 10/13  
 C-Serie (2,3 m) 10/13



Premium, Gamme R/G  
Midlum / Kerax → 09/2005



RENAULT			
348	II e1 03★0184 II (E1) 021022	Truck II ABS	Ø 22 mm
MEKRA LANG Group	Beschreibung description descripción descrizione benamning popis omicaune üzellik leirás opis	mm	OE
61.3481.149H		1	395 x 205 x 145 50.01.856.290
15.3480.840H			372 x 189 x 32
11.3480.100			169 x 88 x 27
61.3480.149H		2	382 x 193 x 85 50.01.853.675 + 50.01.856.292 50.01.833.026
40.3485.412H			375 x 190 x 3

RENAULT



RENAULT			
348	IV e1 03★0185 IV (E1) 021023	Truck IV ABS	Ø 22 mm
MEKRA LANG Group	Beschreibung description descripción descrizione benamning popis omicaune üzellik leirás opis	mm	OE
61.3482.149H			199 x 199 x 97 74.21.276.373
40.3485.403H			191 x 191 x 3



RENAULT			
558	V e1 03★0011 V (E1) 020912	Truck V ABS	
MEKRA LANG Group	Beschreibung description descripción descrizione benamning popis omicaune üzellik leirás opis	mm	OE
59.5580.247H			260 x 229 x 70 50.10.578.511
59.5580.147H			260 x 229 x 70

10/13  
10/13

D-Serie  
C-Serie (2,3 m)



RENAULT			
1025	V e1 04★1345	Truck V ABS	
MEKRA LANG Group	Beschreibung description descripción descrizione benamning popis omicaune üzellik leirás opis	mm	OE
59.1025.001.099			315 x 179 x 220 7484531138
59.1025.002.099			315 x 179 x 220 7484531168

New Regulation ECE R46/04

# SCANIA

<b>400</b>				<b>INTEGR.</b>
	Beschreibung description descripção descrizione description benámenning poppis описание Dzællik leirás opis			
15.4001.840H		432 x 200 x 20	176 5985	
15.4001.740H		184 x 160 x 20	176 7265	

Komplettspiegel erhältlich bei SCANIA  
complete mirror available at SCANIA



Serie 4 (NGS)  
Serie R/P/T/G  
95 - 07/04  
08/04 →

<b>558</b>	V  03★0011 V  020912			
	Beschreibung description descripção descrizione description benámenning poppis описание Dzællik leirás opis			
59.5581.100H		260 x 229 x 77	152 7773	

124 / 144 (Serie 400)  
1996 - 07/04



08/04 →

<b>1005</b>	V  04★1336 V  041336			
	Beschreibung description descripção descrizione description benámenning poppis описание Dzællik leirás opis			
59.1005.003.099		326 x 202 x 214	2382791	

Serie 4 R/P/T/G



2016 →

New Regulation ECE R46/04

<b>1019</b>	<b>NEW</b>	II  041391 IV  041392		
	Beschreibung description descripção descrizione description benámenning poppis описание Dzællik leirás opis			
19.1019.013.099		400 x 208 x 29	2116845	
19.1019.014.099		400 x 208 x 29	2116846	
19.1019.313.099		219 x 196 x 39	2116848	
19.1019.314.099		219 x 196 x 39	2116849	

Serie L/P/G



F7, F 10, F 12  
12/77 - 08/85



250		II e1 01★14002	Truck II	ABS	Ø 14-20 mm
MEKRA LANG Group		Beschreibung description descripção descripziõe descripciön benamining popis omicaawe bùeilik leirras opsis	mm	OE	
51.2500.127H			375 x 183 x 26	1581 550	
40.2500.222H			366 x 176 x 3	1581 599	
51.2500.147H			375 x 183 x 26	1594 412 ÷ 1581 616 1594 411	
40.2500.422H			366 x 176 x 3	1581 602 ÷ 1594 415	
09.2070.101H			2070 x 9 ø	2108 3541	

FL 4, FL 6, FL 7, FL 10  
F 10, F 12, F 16  
NL 10, NL 12  
09/85 - 9/94  
09/85 - 9/93  
1972 - 8/85



252		II E1 02★14089 II E1 0114089	Truck II	ABS	Ø 14-20 mm
MEKRA LANG Group		Beschreibung description descripção descripziõe descripciön benamining popis omicaawe bùeilik leirras opsis	mm	OE	
51.2520.127H			444 x 208 x 84	1599 462 ÷ 3090 395	
40.2520.222H			429 x 194 x 3	1697 007 ÷ 2085 4576	
51.2520.147H			444 x 208 x 84	1594 902 ÷ 1621 353 1195 934 ÷ 3090 396	
40.2520.422H			429 x 194 x 3	1697 008 ÷ 3093 519	
09.2070.101H			2070 x 9 ø	2108 3541	

VOLVO

FH  
FM  
NH  
10/93 - 03/02  
08/98 - 03/02  
05/99 →



370 371		II e1 02★14125 II E1 0114125	Truck II	ABS	INTEGR.
MEKRA LANG Group		Beschreibung description descripção descripziõe descripciön benamining popis omicaawe bùeilik leirras opsis	mm	OE	
15.3702.470H			433 x 198 x 16	3090 737 ÷ 3091 756 3092 854 ÷ 2085 4564	

FH I + FH II  
FM I + FM II



360 360-1		V E1 02★12013 V E1 0112013 V E1 03★0039 V E1 020973	Truck V	ABS	
MEKRA LANG Group		Beschreibung description descripção descripziõe descripciön benamining popis omicaawe bùeilik leirras opsis	mm	OE	
59.3601.128H			284 x 174 x 62	1096 643	
40.3605.204F			272 x 162 x 3	3090 734 ÷ 2085 4583	
59.3601.178H			284 x 174 x 64	2120 3313	
40.3605.203H			272 x 162 x 3		
59.3601.188H			284 x 174 x 64		
40.3605.403H			272 x 162 x 3		
59.3602.128H			284 x 174 x 62	3126 117	
40.3605.204F			272 x 162 x 3	3090 734 ÷ 2085 4583	

# VOLVO

<b>390</b>	II [e1] 03★0009			<b>INTEGR.</b>
	II (E) 020914			
	IV [e1] 03★0037			
	IV (E) 020916			

	Beschreibung		<b>OE</b>
	description		
	descripção		
	descripzione		
	benamning		
	ppois		
	özvevény		
	leírás		
	opsis		

59.3900.143H		880 x 340 x 155	2020 7881 + 2070 7881 2090 3722
59.3900.243H		880 x 340 x 155	2074 3983 + 2132 6527
59.3900.133H		880 x 440 x 155	2070 7874
59.3900.233H		880 x 440 x 155	2070 8303 + 2147 5603 2132 6526
59.3900.343		880 x 340 x 155	
59.3900.443		880 x 340 x 155	
59.3900.333		880 x 440 x 155	
59.3900.433		880 x 440 x 155	
15.3900.840H		337 x 202 x 25	2086 2795
15.3911.871H		200 x 197 x 75	2086 2810
15.3911.872H		200 x 197 x 75	2086 2815
61.3900.100H		373 x 245 x 101	2086 2782
61.3900.110H		373 x 245 x 101	2086 6665
61.3900.120H		373 x 245 x 101	
61.3900.130H		373 x 245 x 101	8512 0820
61.3911.110H		245 x 236 x 105	2086 2809
61.3911.120H		245 x 236 x 105	2086 2813
11.3900.200H		371 x 244 x 80	2086 2779
11.3910.200H		244 x 225 x 75	2086 2800
08.5752.024.099		130 x 120 x 53	2086 6672 + 2086 2812 2161 8499
09.3900.003.000		300 x 6 ø	2161 4025
20.3900.510H		518 x 160 x 98	2070 8110
20.3900.520H		518 x 160 x 98	2070 8230

<b>552-1</b>	V VI [e1] 03★0033			<b>INTEGR.</b>
	V VI (E) 020894			

	Beschreibung		<b>OE</b>
	description		
	descripção		
	descripzione		
	benamning		
	ppois		
	özvevény		
	leírás		
	opsis		

59.5524.648.099		725 x 319 x 126	2084 9837
51.5524.930H		316 x 186 x 77	2102 0285

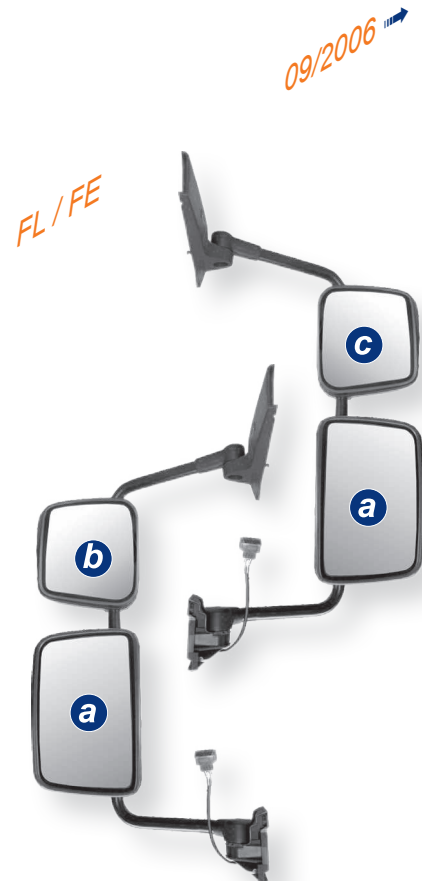

VOLVO

FL/FE



09/06

New Regulation ECE R46/04

VOLVO			
1025	V $\square$ 1 04★1345	Truck	ABS
MEKRA LANG Group		mm	
Beschreibung description descripção descripziune benämning popis omicaune üzellik leirás opis		OE	
59.1025.001.099		315 x 179 x 220	8453 1138
59.1025.002.099		315 x 179 x 220	8453 1168

FH 2 / FM 2



04/02 - 09/2012

224		Truck	ABS	INTEGR.
MEKRA LANG Group		mm		OE
Beschreibung description descripção descripziune benämning popis omicaune üzellik leirás opis				
15.2240.840H		431 x 197 x 30	2056 7670 + 2132 0383	

Komplettspiegel erhältlich bei VOLVO  
complete mirror available at VOLVO

10/10 - 12/2015

FMX



572	II $\square$ 1 03★0031 II (E1) 020918	Truck	ASA	∅ 22 / 28 mm
MEKRA LANG Group		mm		OE
Beschreibung description descripção descripziune benämning popis omicaune üzellik leirás opis				
61.5721.006.099		426 x 200 x 135	8247 1690	
61.5721.005.099		426 x 200 x 135	8247 1688	
40.5725.412H		412 x 188 x 3	8241 7041	
61.5721.004.099		78 x 69 x 38	8247 2612	
11.5721.001.099		427 x 199 x 36	8241 7042	
08.5380.004.000		72 x 75 x 36		



573	IV $\square$ 1 03★0032 IV (E1) 020917	Truck	ASA	∅ 22 / 28 mm
MEKRA LANG Group		mm		OE
Beschreibung description descripção descripziune benämning popis omicaune üzellik leirás opis				
61.5731.001.099		202 x 198 x 126	8247 1689	
40.5735.403H		190 x 184 x 3	8241 7044	
61.5721.004.099		78 x 69 x 38	8247 2612	
11.5731.001.099		202 x 198 x 27	8241 7045	

# VOLVO

<b>1000</b> 1043/1044	II 041541	II 021108			<b>INTEGR.</b>
	II 041540	II 03★0242			
		II 021109			
		II 03★0243			

	Beschreibung description descripção descrizione benamning popis описанье leirás opis		

51.1043.001.099		<b>a</b>	413 x 203 x 75	OE offers only components	<b>MEKRA</b>
51.1043.002.099		<b>a</b>	413 x 203 x 75	OE offers only components	
51.1044.001.099		<b>b</b>	204 x 209 x 88	OE offers only components	
51.1044.002.099		<b>b</b>	204 x 209 x 88	OE offers only components	
09.1000.200.099		<b>1</b>	250		<b>OE</b>
19.1043.001.099		<b>a</b>	406 x 199 x 40		
19.1044.001.099		<b>b</b>	199 x 204 x 54		
13.1043.001.000		<b>a</b>	413 x 203 x 47		
13.1044.001.000		<b>b</b>	204 x 209 x 54		
19.1000.101.099		<b>c</b>	387 x 205 x 41	82356810	
19.1000.121.099		<b>2 c</b>	387 x 205 x 41	24015370	
19.1000.102.099		<b>d</b>	387 x 205 x 41	82359214	
19.1000.122.099		<b>2 d</b>	387 x 205 x 41	24015373	
19.1000.103.099		<b>e</b>	205 x 205 x 55	82356824	

**1** Anschlusskabel (Austausch) für Heizung ab Bj. 05/2019  
heating cable for replacement for vehicles from 05/2019



VOLVO FH 4  
VOLVO FMX  
VOLVO FMD

10/12  
10/15  
2020

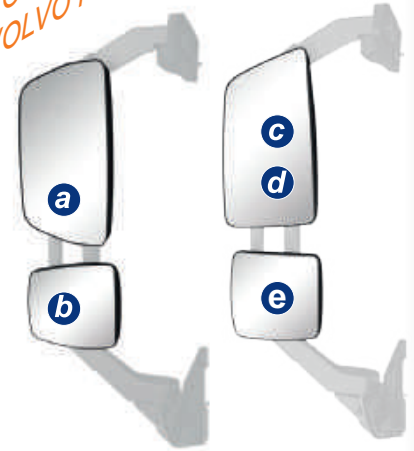

MEKRA OE



Das Blind Spot Modul ist im Lieferumfang nicht enthalten!  
The Blind Spot Modul is not included in the delivery!

# VW

<b>349</b> 349 TW	II e1 02★0384	II 021108			<b>INTEGR.</b>
	II (E1) 010384				

	Beschreibung description descripção descrizione benamning popis описанье leirás opis		

51.3495.110H			283 x 295 x 80	2D1 857 501 A 01C	<b>1</b> LT
15.3491.071H		1800	238 x 142 x 6	2D0 857 521	
51.3495.120H			283 x 340 x 80	2D1 857 502 A 01C	<b>1</b>
15.3491.072H		1800	238 x 142 x 6	2D0 857 522	
51.3495.112H			283 x 295 x 80	2D1 857 501 C 01C	<b>1</b>
15.3491.371H		1800	238 x 142 x 6	2D0 857 521 A	
51.3495.122H			283 x 340 x 80	2D1 857 502 C 01C	<b>1</b>
15.3491.372H		1800	238 x 142 x 6	2D0 857 522 A	
56.3491.110H			175 x 116 x 70		<b>2</b>
15.2711.214H		240	165 x 93 x 15		
56.3492.110H			175 x 116 x 70		<b>2</b>
15.2711.214H		240	165 x 93 x 15		

01/96



Volkswagen LT (Crafter) 05/2006



<b>589</b>	II III <span style="border: 1px solid black; padding: 2px;">e1</span> 03★0006 II III <span style="border: 1px solid black; border-radius: 50%; padding: 2px;">E1</span> 020902			<b>INTEGR.</b>
------------	---	---	---	----------------



Beschreibung  
description  
description  
description  
benamining  
popsis  
ömrcauwe  
öurellik  
reirras  
öpis







1  
1990

\* mit beheizter Weitwinkel - Glaseinheit, nur verwendbar für Fahrzeuge ab "EURO 5" with heated wide angle mirror glass unit, suitable from "EURO 5" vehicles only

LHD	1	51.5891.111.199			344 x 315 x 182	2E1 857 501 E 2E1 857 501 AJ		
		51.5891.112.199 *		12V	344 x 315 x 182	2E1 857 501 Q		
		51.5891.113.199		12V	344 x 315 x 182	2E1 857 501 F		
		51.5891.114.199 *		12V	PARK PILOT	344 x 315 x 182	2E3 857 501 J	
	RHD		51.5894.112.199 *		12V	ohne w/o sans	344 x 315 x 182	2E0 857 513 C
			51.5891.311.199			344 x 345 x 182	2E2 857 501 C 2E2 857 501 N	
			51.5894.310.199		ohne w/o sans	344 x 345 x 182	2E0 857 513 B	
			51.5891.312.199 *		12V		344 x 345 x 182	2E2 857 501 F
	51.5891.313.199		12V		344 x 345 x 182	2E2 857 501 D		
	51.5891.314.199 *		12V	PARK PILOT	344 x 345 x 182	2E4 857 501 K		
LHD		51.5891.211.199			344 x 345 x 182	2E1 857 502 E 2E1 857 502 AK		
		51.5891.212.199 *		12V	344 x 345 x 182	2E1 857 502 P		
		51.5891.213.199		12V	344 x 345 x 182	2E1 857 502 F		
		51.5891.214.199 *		12V	PARK PILOT	344 x 345 x 182	2E3 857 502 K	
RHD		51.5894.212.199 *		12V	ohne w/o sans	344 x 345 x 182	2E0 857 514 B	
		51.5891.411.199			344 x 315 x 182	2E2 857 502 C 2E2 857 502 N		
		51.5894.410.199		ohne w/o sans	344 x 315 x 182	2E0 857 514 A		
		51.5891.412.199 *		12V		344 x 315 x 182	2E2 857 502 F	
	51.5891.413.199		12V		344 x 315 x 182	2E2 857 502 D		
	51.5891.414.199 *		12V	PARK PILOT	344 x 315 x 182	2E4 857 502 L		
LHD	2	51.5892.111.199			344 x 509 x 182	2E3 857 501 D 2E1 857 501 AK		
		51.5892.112.199 *		12V	344 x 509 x 182	2E1 857 501 R		
		51.5892.113.199		12V	344 x 509 x 182	2E3 857 501 F		
	RHD		51.5892.311.199			344 x 460 x 182	2E4 857 501 D 2E4 857 501 AD	
			51.5892.312.199 *		12V	344 x 460 x 182	2E2 857 501 G	
			51.5892.313.199		12V	344 x 460 x 182	2E4 857 501 F	
	51.5895.312.199 *		12V	ohne w/o sans	344 x 460 x 182	2E4 857 513 B		
LHD		51.5892.211.199			344 x 460 x 182	2E1 857 502 D 2E1 857 502 AL		
		51.5892.212.199 *		12V	344 x 460 x 182	2E1 857 502 Q		
		51.5892.213.199		12V	344 x 460 x 182	2E3 857 502 F		
RHD		51.5892.411.199			344 x 509 x 182	2E4 857 502 E		
		51.5892.413.199		12V	344 x 509 x 182	2E4 857 502 G		
		51.5895.412.199 *		12V	ohne w/o sans	344 x 509 x 182	2E4 857 514 B	
LHD	3	51.5893.111.199			344 x 543 x 182	2E3 857 501 E 2E1 857 501 AL		
		51.5893.112.199 *		12V	344 x 543 x 182	2E3 857 501 H		
		51.5893.113.199		12V	344 x 543 x 182	2E3 857 501 G		
		51.5893.211.199			344 x 511 x 182	2E3 857 502 E 2E1 857 502 AM		
		51.5893.212.199 *		12V	344 x 511 x 182	2E3 857 502 J		
		51.5893.213.199		12V	344 x 511 x 182	2E3 857 502 G		

VW



2  
2100

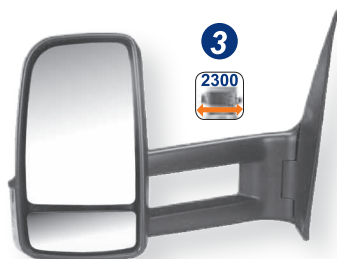

3  
2300





<b>589</b>	II III e1 03★0006		
	II III E1 020902		

MEKRA LANG Group	Beschreibung / description / descrizione / benaming / popis / omicaune / бейлік / optis				mm	OE
15.5891.741H					236 x 155 x 16	2E1 857 587
15.5891.742H					236 x 155 x 16	2E1 857 588
15.5891.611H					154 x 59 x 19	2E1 857 587 A
15.5891.612H					154 x 59 x 19	2E1 857 588 A
19.5890.011.099					240 x 158 x 21	2E0 857 587 A
19.5890.012.099					240 x 158 x 21	2E0 857 588 A
19.5891.011.099					240 x 158 x 21	2E0 857 587 B
19.5891.012.099					240 x 158 x 21	2E0 857 588 B
08.5890.300.099					113 x 32 x 15	2E0 919 473
08.5890.301.099					113 x 32 x 15	2E0 919 473 A
15.5891.721.099					157 x 65 x 20	2E1 857 587 E
15.5891.722.099					157 x 65 x 20	2E1 857 588 E
13.5890.110.199					344 x 218 x 82	2E1 857 516 A
13.5890.210.199					344 x 218 x 82	2E1 857 516 B
13.5890.120.099					344 x 201 x 82	2E0 857 527
13.5890.220.099					344 x 201 x 82	2E0 857 528
14.5890.100.099					337 x 192 x 56	2E1 857 136
14.5890.200.099					337 x 192 x 56	2E1 857 136 A
08.5892.001.099					13 133 x 118 x 88	2E0 953 049 A + 2E0 945 981
08.5892.002.099					13 133 x 118 x 88	2E0 953 049 C + 2E0 945 981
08.5892.003.099					13 133 x 118 x 88	2E0 953 050 A or 2E0 953 050 C + 2E0 945 981
08.5892.004.099					13 133 x 118 x 88	2E0 953 050 B or 2E0 953 049 B + 2E0 945 981
08.5892.105.099					12 51 x 27 ø	2E0 945 981

Volkswagen LT (Crafter) 05/06 - 09/09



a



b

Volkswagen LT (Crafter) EURO 5 + 6 10/2009



c



d



Volkswagen NF (Crafter) 2017



a



b

<b>1013</b>	<b>NEW</b>	II E1 041427			INTEGR.
-------------	------------	--------------	--	--	---------

MEKRA LANG Group	Beschreibung / description / descrizione / benaming / popis / omicaune / бейлік / optis				mm	OE

19.1013.011.099					211 x 169 x 19	VW 7C0 857 521 D VW 7C0 857 521 G
19.1013.012.099					211 x 169 x 19	VW 7C0 857 522 A VW 7C0 857 522 F

# UNIVERSAL

*Agriculture  
Case New Holland, Fendt,  
John Deere, Kässbohrer, KFB etc.*



\* Variante mit 2 Steckern für beheizbare Zusatzspiegel  
version with 2 plug sockets for mounting additional heated mirrors

385		II e1 02★0469 I (E1) 010469		Truck II	ABS	① Ø 14-20 mm ② Ø 20-30 mm
MEKRA LANG Group		Beschreibung description descripção descripzione benämning popis оригинале üzellik leírás opis		mm		OE
51.3850.127H		①	314 x 228 x 65	G 297.810.150.030 (Fendt) AL158964 (John Deere)		
51.3850.227		②	314 x 228 x 65	00437650 (Case New Holland)		
40.2890.222H			300 x 214 x 3	F 297 810 150 010 (Fendt)		
51.3850.137		①	314 x 228 x 65			
40.2890.322			300 x 214 x 3			
10.6211.100			282 x 162			
09.2000.301H			2000 x 9 ø			
51.3850.147H		①	314 x 228 x 65	Y07001023 (KFB) HJ24013370 (VDL)		
51.3850.247		②	314 x 228 x 65	8.688.100.000.0 (Kässbohrer)		
40.2890.422H			300 x 214 x 3			
10.6221.100			282 x 162			
09.2000.301H			2000 x 9 ø			
51.3850.157		①	314 x 228 x 65			
40.2890.322			300 x 214 x 3			
10.6211.100			282 x 162			
51.3850.167H		①	314 x 228 x 65	D072143 (Bredamenarini)		
51.3850.197H *		①	314 x 228 x 65	2097 0652 (Volvo)		
51.3850.267		②	314 x 228 x 65	33.63730-6001 (MAN) D072143 (Bredamenarini)		
40.2890.422H			300 x 214 x 3			
10.6221.100			282 x 162	001 821 00 29 (Mercedes) 8.688.041.029.0 (Setra)		
09.3400.420		②	2000	1905 564 00 (Neoplan) 161.00.77.2027 (MAN Steyr)		

UNIVERSAL

*universal Rampenspiegel*

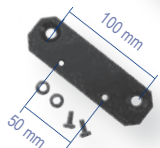

552-1		V VI e1 03★0033 V VI (E1) 020894		Truck V	ABS	
MEKRA LANG Group		Beschreibung description descripção descripzione benämning popis оригинале üzellik leírás opis		mm		OE
59.5520.530H			319 x 187 x 77	1525 537 (DAF) 105137C (Plaxton)		

# UNIVERSAL

<b>300</b>				① Ø 30 mm ② Ø 35 mm
	Beschreibung description descripção descripzione descripção benámenning popis описанье özellik leírás opis			
55.3000.001.001				Ø 306 x 96
55.3000.003.001				Ø 306 x 96
55.3000.002.001				Ø 306 x 88
55.3000.004.001				Ø 306 x 88
51.3000.001.001				Ø 306 x 96
51.3000.002.001				Ø 306 x 88 2401 8790 (Volvo) 3070159 (SCANIA)
61.3000.003.010				47 x 48 x 260
61.3000.004.010				47 x 48 x 260 2401 8822 (Volvo) 3070160 (SCANIA)

Innenspiegel Busse  
EvoBus, Göppel, Hess, Neoplan,  
Scania, VDL, Volvo



<b>750</b>	<b>NEW</b>				INTEGR.
	Beschreibung description descripção descripzione descripção benámenning popis описанье özellik leírás opis				
51.7504.044.001				301 x 141	2320 0690 (Volvo)
20.7504.044.001				230	2328 6290 (Volvo)
20.7504.003.001				71	2328 6294 (Volvo)

Innenspiegel



<b>552-1</b>	V VI  03★0033 V VI  020894				INTEGR.
	Beschreibung description descripção descripzione descripção benámenning popis описанье özellik leírás opis				
59.5524.530H				418 x 492 x 77	27230912 (Terex)
51.5524.930H				316 x 186 x 77	

universal Frontspiegel



<b>389</b>	VI  03★0016 VI  020937				INTEGR.
	Beschreibung description descripção descripzione descripção benámenning popis описанье özellik leírás opis				
59.3891.140H				397 x 557 x 92	
51.3894.140H				Ø 259 x 92	



Montagevarianten  
mounting possibilities  
possibilités de montage  
posibilidades de montagem  
variante del montaggio  
possibilidades de montaje  
monteringsmögijgheter  
Montážní varianty  
Виды монтажа  
montaj montaj olasılikları  
különböző kivitelek  
Możliwości montażu

**A** Dach  
roof  
pavillon  
teto  
tetto  
techo  
tak  
střecha automobilu  
Крышы автомобиля  
kabin üstü  
tetöre szerelt  
Dach

**B** A-Säule  
A-pillar  
montant  
pilar A  
pilastro A  
pilar A  
A - stolpe  
A - sloupek  
A - obr. stolb  
A - sütunu  
A oszlopra szerelt  
Stupek

## UNIVERSAL AGRICULTURE

152 ASKB

II e1 14010



Ø 10 / 12 / 13 mm

MEKRA  
LANG GroupBeschreibung  
description  
descripção  
descripziune  
descripziune  
benamning  
popis  
opis  
opis  
opis

OE

51.1524.119H



260 x 149 x 22

E 178.810.150.019 (Fendt)  
E 178.810.150.010 (Fendt)  
F 178.810.150.020 (Fendt)  
000 811 68 33 (Mercedes)  
639 153 (Scania)

40.1525.114H



252 x 141 x 3

diverse Traktoren / various tractors



289



Ø 16-18 mm

MEKRA  
LANG GroupBeschreibung  
description  
descripção  
descripziune  
descripziune  
benamning  
popis  
opis  
opis  
opis

OE

51.2890.117H



310 x 220 x 25

G 816.810.150.030 (Fendt)  
161 0077 0103 (MAN Steyr)  
81.63730-6170 (MAN)

40.2890.222H



300 x 214 x 3

F 297 810 150 010 (Fendt)

51.2890.147H



310 x 220 x 25

40.2890.422H



300 x 214 x 3

10.6221.100



282 x 162

09.2070.101H



2070 x 9 Ø

10342167 (Liebherr)  
11182172 (Liebherr)Steyr Trucks  
Steyr- + KHD Traktoren

363

II e1 03★0022

II (E1) 020905



Ø 18-28 mm

MEKRA  
LANG GroupBeschreibung  
description  
descripção  
descripziune  
descripziune  
benamning  
popis  
opis  
opis  
opis

OE

51.3635.201



384 x 205 x 120

290-5544 (Caterpillar)  
319-6789 (Caterpillar)  
270011780 (Krone)

51.3636.201



384 x 205 x 120

290-5545 (Caterpillar)  
319-6788 (Caterpillar)

51.3635.204



384 x 205 x 120

294-1991 (Caterpillar)  
316-6791 (Caterpillar)

51.3636.204



384 x 205 x 120

294-1992 (Caterpillar)  
319-6790 (Caterpillar)

15.3802.840H



368 x 189 x 40

8.688.105.263.0 (Kässbohrer)  
11312890 (Krauss-Maffei)  
10470601 (Liebherr)  
AP105367C-3 (Plaxton)  
990115703000 (Tatra)  
48092012 (Terex)

51.3635.206



384 x 205 x 120

688 645 (Fritzmeier)  
8.688.105.000.0 (Kässbohrer)  
44332051000 (Tatra)

51.3636.206



384 x 205 x 120

688 646 (Fritzmeier)  
8.688.106.000.0 (Kässbohrer)  
44332052000 (Tatra)

15.3802.840H



368 x 189 x 40

siehe oben / see above

11.3730.210H



367 x 187 x 60

84434473 (CNH)

DEMAG, Caterpillar



# UNIVERSAL AGRICULTURE

<b>1009</b>	II (E1) 021165			Ø 18-22 mm Ø 28 mm *
-------------	----------------	--	--	-------------------------

	Beschreibung description description descrizione description benamining pops описание birelik letras opis		
--	---	--	--

51.1009.017.099		382 x 232 x 122	372-8075 (Caterpillar) 26143870 (Class) G304810150020 (Fendt) ACV0805960 (Fendt/Valtra) 42154H3480 (Komatsu) 21D-54-41710 (Komatsu) 1000386860 (Kramer) 11068341 (Liebherr) 3010662 (Lindner) 17452496 (Volvo)
51.1009.027.099		382 x 232 x 122	436-2886 (Caterpillar)
51.1009.149.099		382 x 232 x 122	1000390196 (Kramer) 11181691 (Liebherr) 21971360 (Claas)
51.1009.097.099		382 x 232 x 122	1000396281 (Kramer) ACV0148490 (Valtra) 3728076-03 (Carwall) ACV0148490 (Fendt) 42154H3380 (Komatsu) 16281990 (Volvo)
51.1009.025.099		382 x 232 x 122	
51.1009.029.001		382 x 232 x 122	
51.1009.031.001		382 x 232 x 122	
51.1009.045.001		382 x 232 x 122	
51.1009.047.001		382 x 232 x 122	

51.1009.021.099		465 x 231 x 143	26095630 (Claas) G743810150010 (Fendt) 3010850 (Lindner) G743810150020 (Fendt) 26096000 (Claas) 1000379630 (Kramer) 3010851 (Lindner)
51.1009.022.099		465 x 231 x 143	
51.1009.121.099		465 x 231 x 143	3010852 (Lindner)
51.1009.122.099		465 x 231 x 143	1000379641 (Kramer) 3010853 (Lindner)

51.1009.242.099		Ø 28 mm	436-2887 (Caterpillar)
-----------------	--	---------	------------------------

09.2000.301H		2000 x 9 Ø	11181692 (Liebherr)
09.3200.420H		42 x 42 x 54 [2000]	6.200.26.176 (Mauser)

<b>a</b>	51.1009.001.099		291 x 232 x 121	526-5057 (Caterpillar) 3010115 (Lindner) 2186303 (Wirtgen)
	51.1009.081.099		291 x 232 x 121	3010188 (Lindner)
	51.1009.113.099		291 x 232 x 121	22332170 (Claas) AKK34593 (John Deere)
	51.1009.009.099		291 x 232 x 121	545541 (Miller)
	40.1009.001.000		285 x 225 x 2	5653634836 (Terex) F743810150010 (Fendt)
	40.1009.004.099		285 x 225 x 2	ACV0759270 (Fendt/Valtra) 3205677 (Lindner)
	40.1009.001.099		285 x 225 x 2	
<b>b</b>	51.1009.049.099		190 x 109 x 18	
	40.1009.002.000		178 x 92 x 2	5653634837 (Terex) F304810150030 (Fendt)
	40.1009.002.099		178 x 92 x 2	11578550 (Claas) ACV0759280 (Valtra)
	40.1009.005.099		178 x 92 x 2	166352077 (SIAC)
<b>c</b>	61.1009.001.099		196 x 188 x 42	11654110 (Claas)
	61.1009.002.099		196 x 188 x 42	11654120 (Claas)
	40.1009.421.002		180x 170 x 2	F743810150020 (Agco) 11653140 (Claas)
	40.1009.422.002		180x 170 x 2	F749810150030 (Agco) 11653170 (Claas)
<b>d</b>	40.1009.003.099		202 x 138 x 3	

Große Traktoren  
large tractors

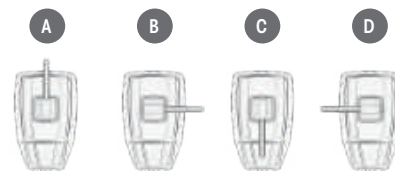

Rohrbindung  
mounting position arm



1 Haupt- und Nahbereichsspiegel  
Main and close proximity mirror



2 Hauptspiegel mit großen  
Nahbereichsspiegel für  
Traktoren ISO 5721-2  
Main - and large close proximity  
mirror for tractors ISO 5721-2



3 Hauptspiegel mit großen  
Nahbereichsspiegel für  
Radbagger ISO14401-2  
Main - and large close proximity  
mirror for Wheel excavator  
ISO14401-2

# UNIVERSAL AGRICULTURE

*Kleine Traktoren  
small tractors*



<b>1010</b>	II (E1) 021228			Ø 14 - 20 mm
	Beschreibung description descripção descripzione descripción benamning popis omicaune üzeylik reirás opis			
51.1010.010.001		284 x 176 x 90	R561145311 (Kubota)	
40.1010.002.099		278 x 169 x 2		

*Teleskopstange  
telescopic bracket*



<b>1017</b>			Ø 22 mm
	Beschreibung description descripção descripzione descripción benamning popis omicaune üzeylik reirás opis		
58.1017.005.099		510 - 800 Teleskop	G-530810150010 (AGCO)
58.1017.006.099		510 - 800 Teleskop	G-530810150020 (AGCO)
58.1017.013.099		510 - 800 Teleskop	
58.1017.014.099		510 - 800 Teleskop	
58.1017.011.099		510 - 800 Teleskop	3009961 (Lindner)
58.1017.012.099		510 - 800 Teleskop	3009999 (Lindner)
58.1017.015.099		510 - 760 Teleskop	
58.1017.016.099		510 - 760 Teleskop	

UNIVERSAL

*Teleskop - System  
telescopic system*



<b>1017+1009</b>	II (E1) 021165			INTEGR.
	Beschreibung description descripção descripzione descripción benamning popis omicaune üzeylik reirás opis			
59.1017.003.099		505 x 543 -> 833		
59.1017.004.099		505 x 543 -> 833		
59.1017.005.099		505 x 543 -> 833	12 V	LF 194 (Amazonen)
59.1017.006.099		505 x 543 -> 833	12 V	LF 195 (Amazonen)
59.1017.009.099		505 x 543 -> 833	12 V	
59.1017.008.099		505 x 543 -> 833	12 V	
59.1017.018.001		505 x 543 -> 833	24 V	
59.1017.019.001		505 x 543 -> 833	24 V	

# UNIVERSAL AGRICULTURE

1036

II (E1) 041459



Ø 22 mm



Beschreibung  
description  
descripção  
descrizione  
description  
benamining  
popsis  
описанье  
özellik  
letras  
opis



51.1036.021.099		487 x 228 x 130		1
51.1036.022.099		487 x 228 x 130		
51.1036.023.099		487 x 228 x 130	26079370 (Claas) 47826941 (CNH)	
51.1036.024.099		487 x 228 x 130	26079500 (Claas) 47904843 (CNH)	
51.1036.025.099		487 x 228 x 130	6-200.26.185 (Mauser)	
51.1036.026.099		487 x 228 x 130		
11.1036.011.099		153 x 144 x 45	11617700 (Claas) 51487075 (CHN) R566924 (John Deere)	
11.1036.012.099		153 x 144 x 45	11617720 (Claas) 51487076 (CNH)	
51.1036.007.099		487 x 228 x 130	47922743 (CNH)	2
51.1036.008.099		487 x 228 x 130	47922744 (CNH)	
51.1036.009.099		487 x 228 x 130	47922739 (CNH) AL232743 (John Deere)	
51.1036.010.099		487 x 228 x 130	47922741 (CNH) AL232744 (John Deere)	
11.1036.013.099		153 x 144 x 45	48025212 (CNH) L221136 (John Deere)	
11.1036.014.099		153 x 144 x 45	48025217 (CNH) L221137 (John Deere)	
19.1036.005.099		299 x 202 x 24	48025196 (CNH)	
19.1036.006.099		177 x 190 x 14	48025209 (CNH)	
19.1036.007.099		299 x 202 x 24	11617730 (Claas) 48025195 (CNH) AL225823 (John Deere)	
19.1036.008.099		177 x 190 x 14	11617740 (Claas) 48025204 (CNH) AL225824 (John Deere)	
19.1036.009.099		299 x 202 x 24		
19.1036.010.099		177 x 190 x 14		
09.3200.420H		42 x 42 x 54 [2000]		

Große Traktoren  
large tractors



1

Vertikale Rohranbindung  
Mounting to vertical tube



2

Horizontale Rohranbindung  
Mounting to horizontal tube



# UNIVERSAL MOTOR HOMES

1018

II (E1) 021281

IV (E1) 021282



ABS

INTEGR.

MEKRA  
LANG Group

Beschreibung  
description  
descripción  
descrizione  
description  
benamning  
pops  
omrøkke  
brevlik  
letras  
opis



OE

1	59.1018.003.099		673 x 245 x 327	284260 (Concorde)
	59.1018.004.099		673 x 245 x 327	284261 (Concorde)
	12.1018.003.099		182 x 64 x 61	
2	59.1018.007.099		699 x 245 x 406	2276379 (Bürstner)
	59.1018.008.099		699 x 245 x 406	207193 (Carthago)
	12.1018.005.099		262 x 64 x 64	
3	59.1018.001.099		727 x 245 x 480	200070726B (Eura Mobil)
	59.1018.002.099		727 x 245 x 480	200070727B (Eura Mobil)
	12.1018.007.099		345 x 64 x 67	2193841 (Bürstner) 201621 / 201622 (Carthago)
	12.1018.001.099		517 x 197 x 70	2193829 (Bürstner) 201619 (Carthago) 2203 3845 (Volvo)
	12.1018.002.099		517 x 197 x 70	2193831 (Bürstner) 201620 (Carthago) 2203 3846 (Volvo)
	15.2780.841F		307 x 177 x 22	8034580 (Hymer)
	19.1018.311.099		178 x 142 x 34	
	19.1018.312.099		178 x 142 x 34	
	12.1018.009.001		226 x 116 x 85	2193839 (Bürstner) 284265 (Concorde) 207195 (Carthago) 175202B-9 (Plaxton) 2193840 (Bürstner)
	12.1018.010.001		226 x 116 x 85	284266 (Concorde) 207196 (Carthago) 175202B-8 (Plaxton)
	09.2910.005.099		3550 x 6 ø	2218519 (Bürstner) 200070749 (Eura Mobil)
	09.2910.002.099		6050 x 6 ø	2218516 (Bürstner) 200070751 (Eura Mobil) 2203 8103 (Volvo)
	08.3200.233H		42 x 42 x 54	200607013 (Bürstner) 112228 (Carthago) 200070818 (Eura Mobil) 1449696 (Hymer) 2092 5244 (Volvo)

BÜRSTNER Grand Panorama 2012  
 CARTHAGO Chic 2012  
 EURA MOBIL Integra 2012  
 CONCORDE, Plaxton, Hymer



**a** Haltefußabdeckung  
cover retaining foot



**b** Tragarmschale oben  
up cover support shaft



**c** Spiegelkopfabdeckung  
mirror head cover

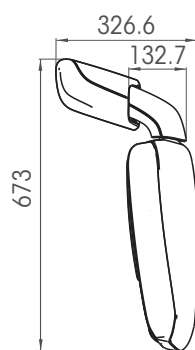

kurz short ①

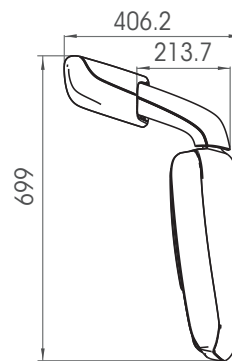

mittel middle ②

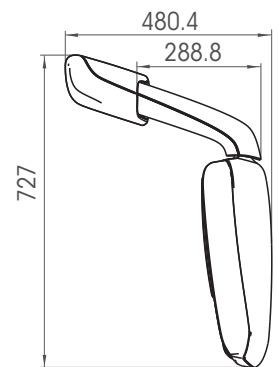

lang long ③



# UNIVERSAL COACHES

271		II e1 02★0524 II (E1) 010524		Truck II ABS PU		A	
MEKRA LANG Group		Beschreibung description description description benamining pops onircauwe birraik leirras opis		mm		OE	
59.2710.401H		703 x 783 x 212	1	284230 (Concorde) 53-707213-710401 (Merkavim) AA-01976 (Plaxton) P758200126 (VDL) 8350 042502 * 7032 8278 (Volvo)			
51.3731.326		384 x 205 x 116		50.06.232.483 (Irisbus) 17294289-0 (Marcopolo) 53-707127-731326 (Merkavim) PAA-01976-1 (Plaxton) 189 3532 (Scania) 1905 503 00 (Solaris) 30022423 (VDL) 7030 9627 * 8706 2719 00059 (Volvo) 8350 035653 (Volvo)			
59.2710.402H		701 x 641 x 200	2	1251 2071 (Carrus) 284232 (Concorde) 53-707213-710402 (Merkavim) 30017729 (VDL) 7302 8283 (Volvo)			
51.3732.326		384 x 205 x 116		D072145 (Bredamenarini) 7036 9682 (Carrus) 50.06.232.482 (Irisbus) 17294289-0 (Marcopolo) PAA-01977-1 (Plaxton) 180 5203 * 189 5048 (Scania) 1905-502-00 (Solaris) 8706 2719 00060 (Volvo) 8350 035654 (Volvo)			
59.2710.454		701 x 801 x 200	3	083895B (Plaxton)			
51.3731.326		384 x 205 x 116		siehe oben / see above			
59.2710.406		701 x 746 x 200	4	284233 (Concorde) AA-01977 (Plaxton)			
51.3732.326		384 x 205 x 116		siehe oben / see above			
15.3731.470H		368 x 189 x 40	a	284248 (Concorde) 425 562 28 (Iveco) PAA-01976-2 (Plaxton) 150 5201 (Scania) 1905 731 470 (Solaris) 30017741 (VDL) 8706 2719 00030 (Volvo)			
15.2711.114		165 x 93 x 25	b	284226 (Concorde) 42545988 (Irisbus) 001 810 60 16 (Mercedes) PAA-01976-3 (Plaxton) 8355 0046556 (Volvo)			
15.2712.114		152 x 128 x 23	c	284228 (Concorde) 42545989 (Irisbus) 001 810 61 16 (Mercedes) PAA-01977-4 (Plaxton) 8350 046557 (Volvo)			
15.2712.113F		152 x 128 x 23	d	7030 60536 (Volvo)			
11.3730.210H		367 x 187 x 60		84434473 (CNH) 425 459 90 * 425 562 27 (Iveco) 150 5202 (Scania) 17294287-7 (Marcopolo) 8706 2719 00052 (Volvo) 1905 770 210 (Solaris)			
20.2700.200H		126 x 25 Ø		1299452 (Hymer)			
20.2710.200H*		183 x 181 x 84		17294281 (Marcopolo) AA-01978 * AA-01979 (Plaxton) 7036 0530 * 8350 046433 (Volvo)			
20.2710.111H		183 x 145 x 107		09-37986101-8 (Marcopolo) 8706 2719 00020 (Volvo) 8350 046970 (Volvo)			
20.2710.121		183 x 145 x 107		09-37986101-8 (Marcopolo) 7032 8290 * 033 1121 (Volvo)			
20.2480.213		108 x 50 x 15 [800]		356 810 06 11 (Mercedes) AA-01980 * AA-01981 (Plaxton)			
20.2480.216H		108 x 50 x 15 [2000]		284240 (Concorde) 83.63731-6507 (MAN) 53-750610-208091 (Merkavim) 145 1226 (Scania) 1970-018-000 (Solaris) P759001645 (VDL) 7033 1124 * 8350 046971 (Volvo)			
20.2480.217H		108 x 50 x 15 [5000]		284242 (Concorde) 425 459 85 (Iveco) 81.63731-6470 (MAN) P107424C-10 (Plaxton) 53-707213-480217 (Merkavim) P759001646 (VDL) 7033 1123 7034 8002 (Volvo) 8706 2719 00018 (Volvo) 8350 046432 (Volvo)			

Reisebusse / Coaches:  
 Avtobus, BMC, Concorde, Dallavia,  
 EvoBus, Euro Coach, Hymer,  
 Ikarbus, Irisbus, Marcopolo, MAZ,  
 LAZ, Plaxton, TEMSA, Tovarna,  
 VDL, Volvo (7500 DD, 7700, 8700,  
 City Bus, 9300, 9700, Interregio),  
 Wrightbus

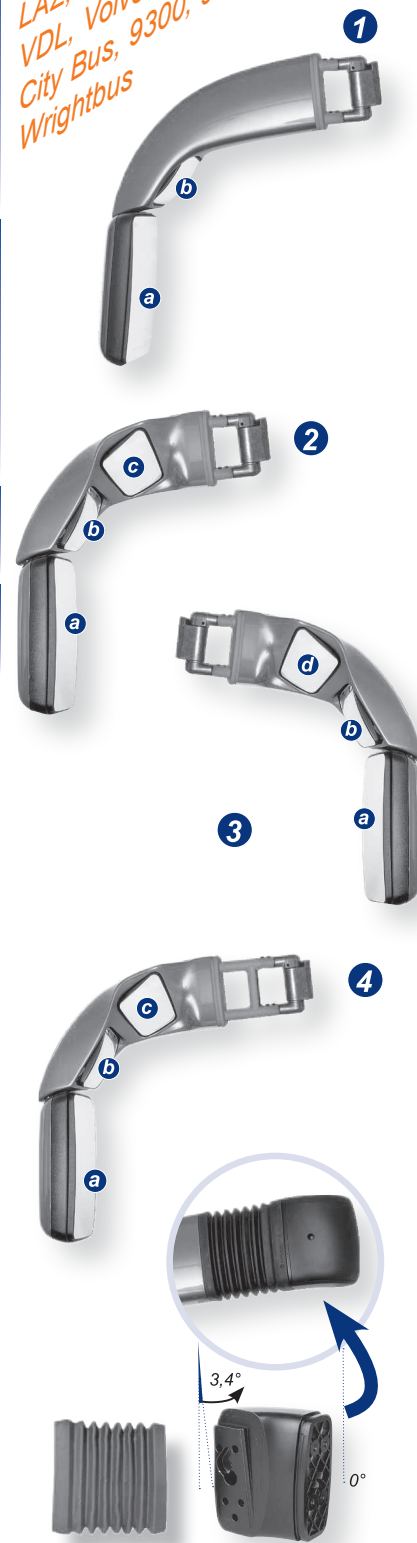

\* für  
für  
pour  
59.2710.406  
2 pieces necessary

# UNIVERSAL COACHES

<b>291</b>	II (E1) 021203			<b>INTEGR.</b>
	IV (E1) 021207			

	Beschreibung description descripción descrizione benámenning popis ömrcauwe öreilikk opis		<b>OE</b>
--	---	--	-----------

CAETANOBUS Cobus 3000  
 CONCORDE Charisma III  
 HESS  
 MAN Lion's City  
 PLAXTON Panther  
 PLAXTON Elite  
 RUNIRAN R9700  
 TEMSA Safir  
 TEMSA Safir  
 TEMSA MD 9  
 VISEON C-Serie  
 Volvo 9700 / 9900  
 VDL Futura

01/2012 →  
 08/2012 →  
 01/2011 →  
 10/2012 →  
 2011 →  
 10/2010 →  
 05/2011 →  
 06/2011 →  
 10/2011 →



1

Spiegel mit HS, WWS  
mirror with HS, WWS



2

Spiegel mit HS und Bugspiegel  
mirror with HS and front crossview mirror

<b>1</b>	59.2910.001.001		1196 x 696 x 239	284215 (Concorde) 5053-APA-06Y (TEMSA) 44.17604-0317 (Viseon) 2187 9369 (Volvo)
	59.2910.002.001		1196 x 696 x 239	284216 (Concorde) 5053-APA-04Y (TEMSA) 44.17604-0318 (Viseon) 2189 4545 (Volvo)
	59.2910.012.001		1196 x 696 x 239	
	59.2910.019.001		1196 x 696 x 239	203722 (Carthago)
	59.2910.020.001		1196 x 696 x 239	203723 (Carthago)
	59.2910.009.001		1196 x 969 x 239	AP140857C-1 (Plaxton)
	59.2910.010.001		1196 x 696 x 239	AP119170C-2 (Plaxton) MD301145Y (TEMSA)
	59.2910.005.001		1196 x 696 x 239	2202 6968 (Carrus)
	59.2910.006.001		1196 x 696 x 239	
	59.2910.015.001		1196 x 696 x 239	22360737 (Volvo)
	59.2910.016.001		1196 x 696 x 239	22360738 (Volvo)
	<b>2</b>	59.2910.003.001		1196 x 696 x 239
59.2910.004.001			1196 x 696 x 239	HD301144Y (TEMSA) 44.17604-0322 (Viseon) 2187 9404 (Volvo)
59.2910.017.001			1196 x 696 x 239	158388C (Plaxton)
59.2910.018.001			1196 x 696 x 239	158396C (Plaxton)
<b>3</b>	59.2910.007.001		1196 x 696 x 239	
	59.2910.008.001		1196 x 696 x 239	2202 6977 (Volvo)
<b>4</b>	59.2910.013.001		1196 x 696 x 239	248268 (Concorde)
	59.2910.014.001		1196 x 696 x 239	248269 (Concorde)



3

Spiegel mit HS, WWS und ZS (links)  
mirror with HS, WWS and ZS (left)



4

Spiegel mit HS, WWS und NBS (rechts)  
mirror with HS, WWS and NBS (right)

# UNIVERSAL COACHES

<b>291</b>	II (E1) 021203			INTEGR.
	IV (E1) 021207			

	Beschreibung description descripción descrizione beschrijving opis oíríreacúine översikt opis		
--	---	--	--

61.2910.001.001		262 x 150		<b>3</b>
61.2910.002.001		262 x 150	22117455 (Volvo)	
61.2910.003.001		312 x 150	5053-APA-05Y (Temsas)	<b>4</b>
61.2910.004.001		312 x 150	5053-APA-03Y (Temsas)	
61.2910.007.001	(with LED )	312 x 150	22117457 (Volvo)	<b>5</b>
61.2910.008.001	(with LED )	312 x 150	21885965 (Volvo)	
61.2910.005.001		412 x 150	HD 301152 (Temsas)	<b>5</b>
61.2910.006.001		412 x 150	HD 301151 (Temsas)	
61.2910.021.001		412 x 150	284217 (Concorde)	<b>5</b>
61.2910.022.001		412 x 150	284218 (Concorde)	
09.2910.007.000		1050 x 6 ø		<b>5</b>
09.2910.004.099		2750 x 6 ø	201931 (Carthago)	
09.2910.005.099		3550 x 6 ø	2218519 (Bürstner) 200070749 (Eura Mobil)	<b>5</b>
09.2910.002.099		6050 x 6 ø	2218516 (Bürstner) 284221 (Concorde) 200070751 (Eura Mobil) 44.15240-0300 (Viseon) 2203 8103 (Volvo)	
09.2910.003.099	(for LED  or )	6050 x 6 ø	22212554 (Volvo)	<b>5</b>
09.2770.001.000		6050 x 6 ø		
08.3200.233H		42 x 42 x 54	20925244 (Volvo)	

CAETANOBUS Cobus 3000 01/2012  
 CONCORDE Charisma III 08/2012  
 HESS  
 MAN Lion's City  
 PLAXTON Panther  
 PLAXTON Elite  
 RUNIRAN R9700  
 TEMSA Safari  
 TEMSA Safir  
 TEMSA MD 9  
 VISEON C-Serie  
 Volvo 9700 / 9900  
 VDL Futura

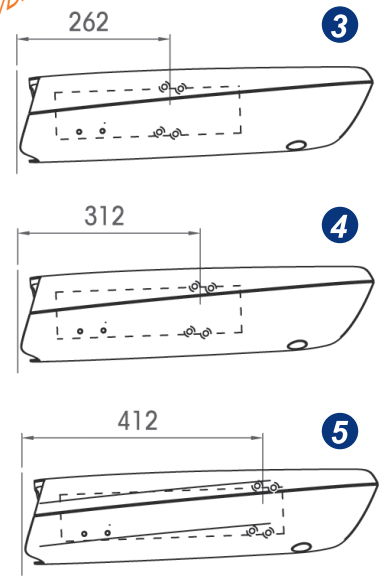

15.2780.840		307 x 177 x 22	81.63733-0113 (MAN) P119170C-8 (Plaxton) 5053-APA-04-01Y (TEMSA) 30017846 (VDL) 48.17600-0026 (Viseon)
15.2780.841F		307 x 177 x 22	201932 (Carthago)
19.2910.001.099		184 x 154 x 31	P119170C-7 (Plaxton) 5053-APA-04-03Y (TEMSA)
19.2910.002.099		184 x 172 x 39	HD301144-02Y (TEMSA)
08.3950.001.099	Control Unit for	40 x 30 x 30	22038110 (Volvo)
08.2910.001.002	LED		22488075 (Volvo)
61.5590.001.099	for <b>3</b> and <b>4</b>	256 x 165 x 82	
11.2910.001.000	für für pour  back	597 x 105 x 66	
11.2910.002.000	für für pour  back	617 x 112 x 105	
11.2910.003.000	für für pour  front	651 x 112 x 146	
11.2910.004.000	für für pour  front	509 x 112 x 123	
11.2910.006.000	für für pour  back	597 x 105 x 66	
11.2910.007.000	für für pour  back	617 x 112 x 105	
11.2910.008.000	für für pour  front	651 x 112 x 146	
11.2910.009.000	für für pour  front	509 x 112 x 123	
11.2910.011.002	für für pour	514 x 225 x 121	
11.2910.012.002	für für pour	514 x 225 x 121	

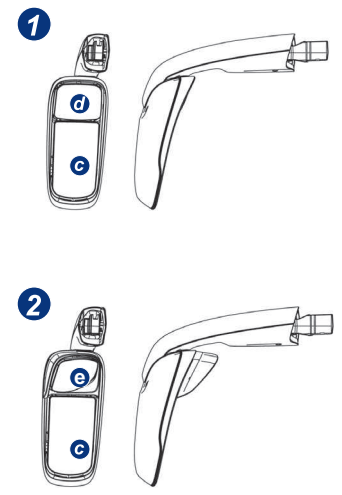









UNIVERSAL



# UNIVERSAL ACCESSORIES



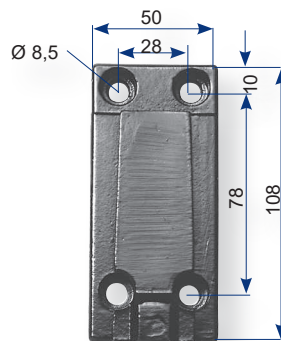

## 248/2 A

		Beschreibung description description description description benámening popis описання leirás opis		 mm	
20.2480.210H			108 x 50 x 15	5571298 (Bomag) D067504 (Bredamenarini) 218 142 (Fritzmeier) 84433427 (Case New Holland) 7621216 (Liebherr) 17294377-6 (Marcopolo) 671 811 0111 (Mercedes) P105367C-15 (Plaxton) 144 8217 (Scania) 7035 2646 (Volvo) 8706 2719 00055 (Volvo)	
20.2480.211H			108 x 50 x 15 [2500]	145 1227 (Scania) 1990-685-650 (Solaris) 2085 4088 (Volvo) 8350 003620 (Volvo)	
20.2480.223			108 x 50 x 15 [150]	81.63731-6478 (MAN) 17294378-2 (Marcopolo) 2051 5454 (Volvo) 8706 2719 00040 (Volvo)	
20.2480.213			108 x 50 x 15 [800]	356 810 06 11 (Mercedes) AA-01980 / AA-01981 (Plaxton)	
20.2480.216H			108 x 50 x 15 [2000]	284240 (Concorde) VI-10-01-010 (Eura Mobil) R21640 (Lahden) 83.63731-6507 (MAN) 53-750610-208091 (Merkavim) 145 1226 (Scania) 1970-018-000 (Solaris) P759001645 (VDL) 7033 1124 / 8350 046971 (Volvo) 284242 (Concorde) 425 45985 (Iveco) 77037873 (Komatsu)	
20.2480.217H			108 x 50 x 15 [5000]	R21645 (Lahden) 81.63731-6470 (MAN) 53-707213-480217 (Merkavim) P107424C-10 (Plaxton) P759001646 (VDL) 7033 1123 / 7034 8002 (Volvo) 8350 046432 / 8706 2719 00018 (Volvo)	

Aufsteckkeile  
Mounting wedges



## 271 A

		Beschreibung description description description description benámening popis описання leirás opis		 mm	
20.2710.620			124 x 59 x 21 [500]	200083489 (Eura Mobil) 50.00.021.163 (Irisbus) 17042340N0000 (Krauss-Maffei) 53-707213-710620 (Merkavim) 7033 1941 (Volvo)	

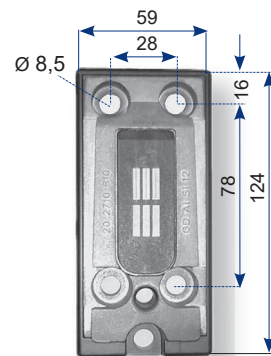

# UNIVERSAL AGRICULTURE

1016



Ø 22 mm

Beschreibung  
description  
descrição  
descriptione  
description  
benämning  
pops  
omicaue  
üzeylik  
opis



OE

Haltestangen brackets

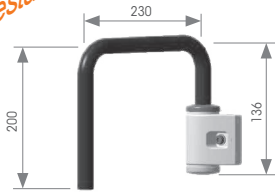

U-Form  
U-shape

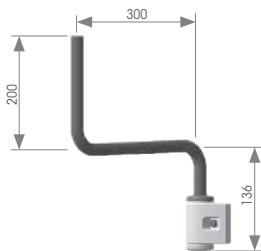

Z-Form  
Z-shape

U	58.1016.001.099	<b>1</b>	200 x 230 x 136
	58.1016.002.099	<b>1</b>	200 x 230 x 136
	58.1016.003.099	<b>2</b>	200 x 230 x 136
	58.1016.004.099	<b>2</b>	200 x 230 x 136
Z	58.1016.005.099	<b>1</b>	336 x 300
	58.1016.006.099	<b>1</b>	336 x 300
	20.1016.004.000	Sechskant hex attachment for <b>1</b>	

## Manuell verstellbar in 30°-Stufen

Manually adjustable in steps of 30°

## Montage von Innenseite Fahrzeug verschraubt (Variante 2) oder von außen mittels Sechskant verschweißt (Variante 1) möglich

Mounting base bolted through hex attachment (Version 1) or directly bolted from vehicle side (Version 2)

## Sowohl hängend als auch stehend montierbar (Darstellung: stehend)

Tube can be turned upside down hanging and standing (Shown: standing)

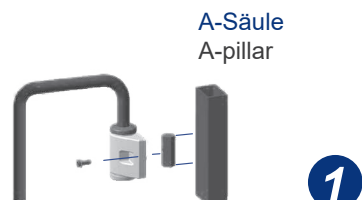
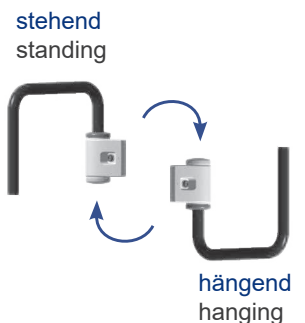

Montage von Außenseite Fahrzeug verschweißt  
Mounting base bolted through hex attachment

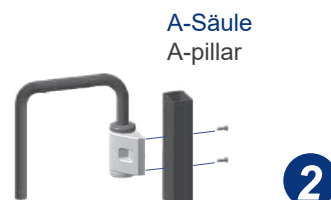

Montage von Innenseite Fahrzeug verschraubt  
Mounting directly bolted from vehicle side

# UNIVERSAL BUSES

270 A		st		Ø 28 mm	
MEKRA LANG Group		mm		OE	
Beschreibung description description description benamining Pops описание betraks opis					
58.2704.051H		90°	270 x 464 x 28 ø	0783032 (Dethleffs) 1905-509-025 (Solaris)	1
58.2704.048		90°	216 x 514 x 28 ø	HEO 627 810 M1 47 (EvoBus) 3600100512654 (Evobus) 1905-508-000 (Solaris) 0000-217-083 (Solaris) 7032 8298 (Volvo) 7033 1060 (Volvo) 2053 5857 (Volvo)	2
58.2704.044		90°	216 x 514 x 28 ø	7032 8298 (Volvo) 7033 1060 (Volvo) 2053 5857 (Volvo)	
58.2704.088		120°	216 x 514 x 28 ø	50.06.232.165 (Irisbus)	
58.2704.070		6°	732 x 327 x 28 ø	1905-509-000 (Solaris) 7032 8294 (Volvo)	3
58.2704.086		6°	732 x 327 x 28 ø	1905 500 010 (Solaris) 2056 4284 (Volvo)	
58.2704.093		6°	732 x 327 x 28 ø	1905-506-010 (Solaris)	
58.2705.003		17°	668 x 350 x 28 ø	7035 2000 (Volvo)	4
58.2705.001H		17°	668 x 350 x 28 ø	7030 9620 (Volvo) 8706 2719 00056 (Volvo) VG10037.000 (Volvo)	
61.2708.842H				150 5203 (Scania)	
61.2703.110		128°	156 x 129 x 36	000 810 04 12 (Mercedes)	
61.2703.120		56°	156 x 129 x 36	000 810 05 12 (Mercedes)	

Haltestangen brackets

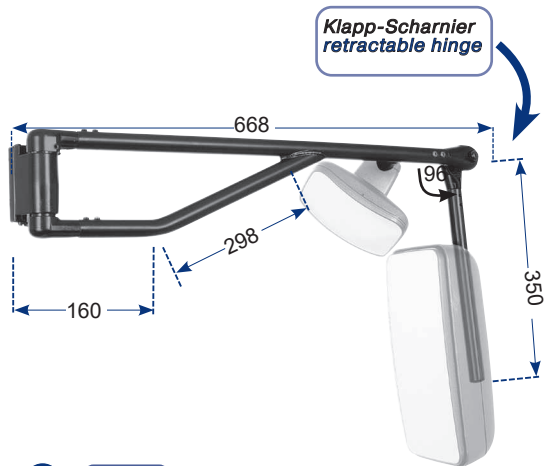
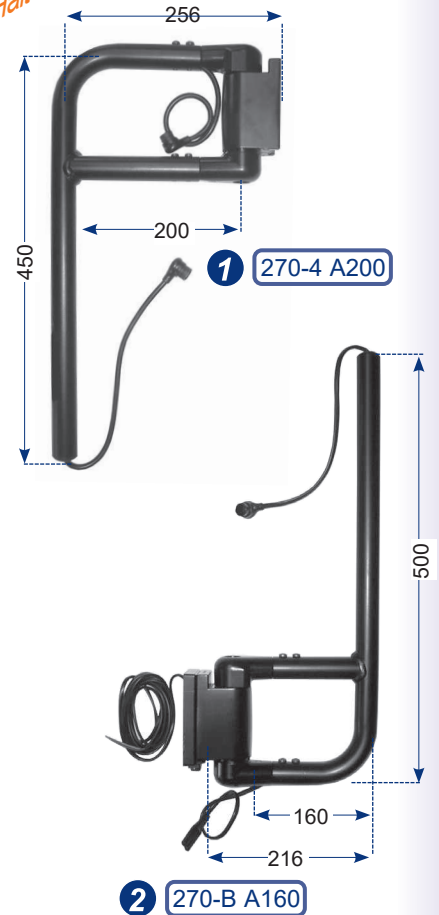

4 270-5

Klappstange  
hinged tube

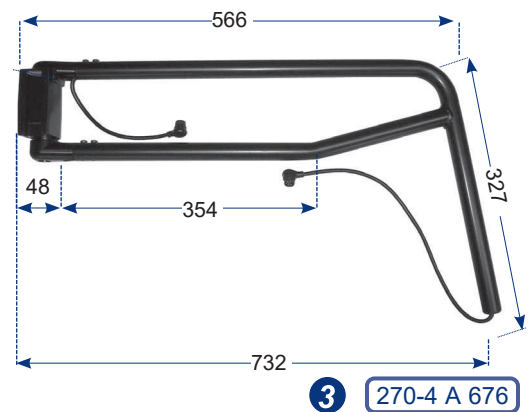

3 270-4 A 676

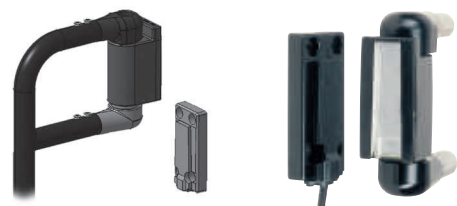

UNIVERSAL

# ALLGEMEINE GESCHÄFTSBEDINGUNGEN (AGB)

## I. Allgemeine Bedingungen

Den Vertragsbeziehungen zwischen uns, MEKRA Lang GmbH & Co. KG („MEKRA Lang“), und unseren Bestellern, die Unternehmer im Sinne des § 14 BGB sind, liegen ausschließlich die nachfolgenden AGB zugrunde. Abweichende Geschäftsbedingungen des Bestellers werden, selbst bei Kenntnis, nicht Vertragsbestandteil. Unsere Angebote sind stets freibleibend. Unsere AGB gelten mit der Auftragserteilung, spätestens mit der Annahme der Ware als anerkannt. Diese AGB gelten bei ständigen Geschäftsbeziehungen auch für alle künftigen Geschäfte. Sollten einzelne Bestimmungen ganz oder teilweise unwirksam sein oder werden, so wird hierdurch die Gültigkeit der übrigen Bestimmungen nicht berührt. In diesem Fall werden MEKRA Lang und der Besteller eine Regelung vereinbaren, deren wirtschaftlicher Erfolg dem der unwirksamen Regelung möglichst nahe kommt. Bis dahin gilt die Gesetzeslage.

## II. Vertragsschluss und Preise

- Mit der Bestellung einer Ware erklärt der Besteller verbindlich, die bestellte Ware erwerben zu wollen. Er ist an diese Erklärung zwei Wochen gebunden. Wir sind berechtigt, das in der Bestellung liegende Vertragsangebot innerhalb von zwei Wochen nach Eingang bei uns anzunehmen. Die Annahme kann schriftlich, elektronisch oder durch Auslieferung der Ware an den Besteller erklärt werden.
- Die Verpflichtungen im elektronischen Geschäftsverkehr gem. § 312a Abs. 1 Satz 1 Nr. 1 bis 3 und Satz 2 BGB werden ausgeschlossen.
- Der Vertragsschluss erfolgt unter dem Vorbehalt der richtigen und rechtzeitigen Selbstbelieferung durch unsere Zulieferer. Dies gilt nur für den Fall, dass die Nichtbelieferung nicht von uns zu vertreten ist, insbesondere bei Abschluss eines kongruenten Deckungsgeschäftes mit unseren Zulieferern. Der Besteller wird über die Nichtverfügbarkeit der Leistung unverzüglich informiert und die Gegenleistung, soweit bereits geleistet, unverzüglich zurückerstattet.
- Alle vertraglichen Zahlungsverpflichtungen sind ausschließlich in EURO zu erfüllen.
- Die Preise verstehen sich netto ab Werk bzw. Auslieferungslager. Fracht-, Verpackungs-, Einfuhrkosten, Zoll und sonstige Nebenabgaben gehen zu Lasten des Bestellers.

## III. Lieferzeit und Lieferverpflichtung

- Für Umfang, Art und Zeitpunkt der Lieferung ist unsere schriftliche oder elektronische Auftragsbestätigung maßgebend. Teil-Lieferungen sind zulässig.
- Eine Verpflichtung zur Einhaltung als verbindlich bezeichneter Lieferfristen wird nur unter der Voraussetzung eines ungestörten Betriebs- und Vertriebsablaufs übernommen; insbesondere in Fällen höherer Gewalt und sonstiger störender Ereignisse bei uns, bei unseren Lieferanten oder bei den Transportunternehmern, beispielsweise Betriebs- oder Verkehrsstörungen, Feuer, Überschwemmungen, Arbeitskräfte-, Energie- oder Verkehrsmangel, Streik, Aussperrung, behördliche Maßnahmen sowie technische oder technologische Umstände, welche die Auftragsausführung wesentlich erschweren, entbinden uns von der Pflicht zur rechtzeitigen Lieferung oder geben uns das Recht, unsere Lieferung ohne Nachlieferpflicht einzustellen.
- Sofern nichts Abweichendes vereinbart ist, sind wir berechtigt, bereits vor einem genannten Liefertermin zu leisten. Ebenso gilt, sofern nichts Abweichendes vereinbart ist, eine bis maximal zwei Wochen über einem genannten Liefertermin liegende Leistung unsererseits nicht als verspätet.
- Lieferfristen gelten als eingehalten, wenn bis zu ihrem Ablauf die Ware das Werk oder Auslieferungslager verlassen hat oder dem Besteller die Anzeige unserer Versandbereitschaft zugegangen ist. Nachträgliche Änderungen des Vertrages verlängern die Lieferfristen angemessen.
- Bei Verträgen, deren Erfüllung aus mehreren Lieferungen besteht, ist Nichterfüllung, oder mangelhafte oder verspätete Erfüllung einer Lieferung ohne Einfluss auf andere Lieferungen aus dem Vertrag.
- Zahlungsverzug, die Abgabe einer eidesstattlichen Offenbarungsversicherung gemäß § 807 ZPO, eintretende Zahlungsschwierigkeiten oder das Bekanntwerden einer wesentlichen Verschlechterung der Vermögensverhältnisse des Bestellers berechtigen uns nach unserer Wahl, für noch offenstehende Lieferungen Vorauszahlung zu verlangen oder Lieferungen sofort einzustellen und die Erfüllung laufender Verträge zu verweigern. Gleichzeitig sind wir berechtigt, noch nicht fällige Forderungen gegen den Besteller sofort fällig zu stellen.

## IV. Versand, Gefahrenübergang

- Verpackung, Versandweg und Transportmittel sind unserer Wahl überlassen, es sei denn, es ist zwischen den Parteien etwas anderes vereinbart.
- Die Gefahr des zufälligen Untergangs und der zufälligen Verschlechterung der Ware geht mit der Übergabe, beim Versandkauf mit der Auslieferung der Sache an den Spediteur, den Frachtführer oder der sonst zur Ausführung der Versendung bestimmten Person oder Anstalt, auf den Besteller über. Der Übergabe steht es gleich, wenn der Besteller im Verzug der Annahme ist.
- Ware aus Abrufaufträgen ist, wenn nicht anders vereinbart, innerhalb von 3 Monaten nach Erteilung der Auftragsbestätigung abzunehmen.
- Versicherung gegen Bruch- und Transportrisiken werden nur auf besonderen Wunsch gegen Berechnung der Kosten übernommen.
- Zoll und sonstige Spesen, auch die Unkosten für Bezahlung der zur Einfuhr in das Bestimmungsland notwendigen Papiere, gehen zu Lasten des Käufers.

## V. Zahlung, Zahlungsbedingungen

- Rechnungen sind zahlbar:
  - innerhalb von 14 Tagen ab Rechnungsdatum mit 2 % Skonto vom Rechnungswert.
  - innerhalb von 30 Tagen ab Rechnungsdatum ohne Skonto vom Rechnungswert.
- Kassa - Skonto wird nur gewährt, wenn sämtliche Zahlungsverpflichtungen aus früheren Lieferungen erfüllt sind und der Rechnungsbetrag pünktlich bis zu den vorgeannten Fälligkeitstagen bei uns in bar vorliegt oder unserem Konto gutgeschrieben ist. Wechselheringabe kann also nicht zur Gewährung von Kassa -Skonto führen. Bei bargeldloser Zahlung, insbesondere auch bei Scheckheringabe, kommt es auf den Zeitpunkt

der Gutschrift an. Bei Zahlung oder Gutschrift unter Vorbehalt, unter einer Bedingung oder sonstigen Einschränkungen kann Skonto nicht gewährt werden. Das Risiko des Zahlungsweges trägt der Besteller. Rechnungen für Werkzeuge sind ohne Skontoabzug sofort zahlbar.

- Die Annahme von Wechseln und Schecks erfolgt nur erfüllungshalber. Entsprechende Gutschriften erfolgen nur unter Vorbehalt des Einganges des vollen Betrages. Die Hereinnahme von fremden oder eigenen Akzepten behalten wir uns vor. Kosten und Diskontospesen gehen zu Lasten des Bestellers. Eine Gewähr für Vorlage und Protest übernehmen wir nicht. Protesterhebung eigener Wechsel des Bestellers oder nicht sofortige Abdeckung protestierter Fremdwechsel ermächtigen uns, sämtliche noch laufende Wechsel zurückzugeben. Gleichzeitig sind wir berechtigt, nicht fällige Forderungen gegen den Besteller sofort fällig zu stellen. Vordatierte Schecks werden nicht angenommen.
- Bei Überschreitung des Zahlungstermins werden Verzugszinsen in Höhe von 9 %-Punkten über dem jeweiligen Basiszinssatz gem. § 247 BGB sowie eine Verzugschadenspauschale in Höhe von 40,00 Euro gem. § 288 Abs. 5 BGB fällig. Die Geltendmachung eines weiteren Verzugschadens oder anderer Rechte bleibt vorbehalten.
- Voraus- und Abschlagszahlungen werden nicht verzinst.
- Zur Aufrechnung oder Einbehaltung von Zahlungen ist der Besteller nur berechtigt, wenn seine Gegenforderung unbestritten oder rechtskräftig festgestellt ist. Der Besteller kann ein Zurückbehaltungsrecht nur ausüben, wenn sein Gegenanspruch auf demselben Vertragsverhältnis beruht.
- Beim Ausgleich von Rechnungen sind vom Besteller seine Kundennummer und die Rechnungsnummer anzugeben. Verzögerungen oder Fehlbuchungen, die infolge Nichteinhaltung dieser Verpflichtungen eintreten, gehen zu Lasten des Bestellers.

## VI. Eigentumsvorbehalt, Factoring

- Die gelieferte Ware bleibt bis zur Bezahlung aller bestehenden Forderungen aus der Geschäftsverbindung mit dem Besteller unser Eigentum. Der Besteller ist im Rahmen des ordnungsgemäßen Geschäftsganges zur Weiterveräußerung der Vorbehaltsware berechtigt; eine Verpfändung oder Sicherungsübereignung ist ihm jedoch nicht gestattet. Bei einem Weiterverkauf von Vorbehaltsware auf Kredit ist er verpflichtet unsere Rechte zu sichern.
- Die Forderungen des Bestellers aus der Weiterveräußerung der Vorbehaltsware tritt dieser schon jetzt in Höhe des Rechnungsbetrages an uns ab; Wir nehmen diese Abtretung an. Ungeachtet der Abtretung ist der Besteller zur Einziehung solange berechtigt, als er seinen Verpflichtungen uns gegenüber aus dem zugrundeliegenden Vertragsverhältnis nachkommt und nicht in Vermögensverfall gerät. Andernfalls hat er auf unser Verlangen die zur Einziehung erforderlichen Angaben über die abgetretene Forderung zu machen und seinen Schuldnern diese Abtretung anzuzeigen. Für diesen Fall behalten wir uns vor, die Forderung selbst einzuziehen.
- Eine etwaige Be- oder Verarbeitung der Vorbehaltsware durch den Besteller erfolgt stets im Namen und im Auftrag für uns, ohne dass uns jedoch Verbindlichkeiten hieraus erwachsen dürfen. Bei der Verarbeitung der Vorbehaltsware mit anderen, uns nicht gehörenden Waren, steht uns der dabei entstandene Miteigentumsanteil an der neuen Sache im Verhältnis des Wertes der Vorbehaltsware zu der übrigen verarbeiteten Ware zu. Soweit hier und auch nachfolgend auf den Wert der Vorbehaltsware abgestellt ist, ergibt sich diese aus unserem Fakturwert.
- Erwirbt der Besteller das Alleineigentum an der neuen Sache gemäß § 947 Abs. 2 BGB, so besteht Einigkeit darüber, dass er uns im Verhältnis des Wertes der verarbeiteten bzw. verbundenen oder vermischten Vorbehaltsware Miteigentum an der neuen Sache einräumt und diese unentgeltlich für uns bewahrt.
- Wird die Vorbehaltsware zusammen mit anderen Waren, und zwar gleichgültig, ob ohne oder nach Verarbeitung, Verbindung oder Vermischung weiter veräußert, so gilt die oben vereinbarte Vorausabtretung nur in Höhe des Wertes der Vorbehaltsware, die zusammen mit den anderen Waren weiterveräußert wird. Wir verpflichten uns, die uns nach den vorstehenden Bestimmungen zustehenden Sicherungen auf Verlangen insoweit freizugeben, als der Wert die zu sichernden Forderungen mit 20 % übersteigt.
- Über Zwangsvollstreckungsmaßnahmen Dritter in die Vorbehaltsware oder die im Voraus abgetretenen Forderungen hat uns der Besteller unverzüglich unter Übergabe der für eine Intervention notwendigen Unterlagen zu unterrichten. Daraus bei uns entstehende Interventionskosten sind vom Besteller zu tragen.
- Der Besteller hat die Vorbehaltsware ausreichend gegen Feuer und Einbruchsdiebstahl zu versichern und uns dies auf Verlangen nachzuweisen.

## VII. Mängelansprüche

- Die Verjährungsfrist für Mängelansprüche beträgt 24 Monate ab Ablieferung der Ware.
- Wir leisten für Mängel der Ware zunächst nach unserer Wahl Gewähr durch Nachbesserung oder Ersatzlieferung. Bei Fehlschlägen von Nachbesserung oder Ersatzlieferung kann der Besteller Rückgängigmachung des Vertrages oder Herabsetzung der Vergütung verlangen. Bei einer nur geringfügigen Vertragswidrigkeit, insbesondere bei nur geringfügigen Mängeln, steht dem Besteller jedoch kein Rücktrittsrecht zu.
- Der Besteller hat offensichtliche Mängel unverzüglich, spätestens innerhalb von 7 Tagen nach Eingang der Ware unter sofortiger Einstellung etwaiger Bearbeitung schriftlich anzuzeigen. Andernfalls ist die Geltendmachung von Mängelansprüchen ausgeschlossen. Zur Fristwahrung genügt die rechtzeitige Absendung. Den Besteller trifft die volle Beweislast für sämtliche Anspruchsveroraussetzungen, insbesondere für den Mangel selbst, für den Zeitpunkt der Feststellung des Mangels und für die Rechtzeitigkeit der Mängelrüge.
- Mängel, die auch bei sorgfältiger Prüfung innerhalb dieser Frist nicht entdeckt werden können, sind unverzüglich nach Entdeckung schriftlich zu rügen. Wählt der Besteller wegen eines Rechts- oder Sachmangels nach gescheiterter Nacherfüllung den Rücktritt vom Vertrag, steht ihm daneben kein Schadensersatzanspruch wegen des Mangels zu.
- Wählt der Besteller nach gescheiterter Nacherfüllung Schadensersatz, verbleibt die Ware beim Besteller, wenn ihm dies zumutbar ist. Der

Schadensersatz beschränkt sich auf die Differenz zwischen Kaufpreis und Wert der mangelhaften Sache. Dies gilt nicht, wenn wir die Vertragsverletzung arglistig verursacht haben.

- Ware, für die wir Ersatz geleistet haben, geht in unser Eigentum über und ist an uns zurückzusenden gegen Kostenerstattung.
- Ansprüche bestehen nicht für solche Schäden, die dadurch entstanden sind, dass der Besteller schuldhaft
  - den Kaufgegenstand unsachgemäß behandelt oder überanspricht hat oder
  - den Kaufgegenstand in einer nicht vereinbarten Weise verändert hat oder
  - die Vorschriften der Montage- oder Betriebsanleitung nicht befolgt hat oder
  - die Rüge- und Zustellungspflicht gemäß vorstehender Ziffer 3 und 4 verletzt hat oder
  - den Kaufgegenstand nach Mangelfeststellung weiterbenutzt hat.
 Natürlicher Verschleiß ist von der Gewährleistung ausgenommen.

## VIII. Haftung

- Bei leicht fahrlässigen Pflichtverletzungen beschränkt sich unsere Haftung auf den nach der Art der Ware vorhersehbaren, vertragstypischen, unmittelbaren Durchschnittsschaden. Dies gilt auch bei leicht fahrlässigen Pflichtverletzungen unserer gesetzlichen Vertreter oder Erfüllungsgehilfen. Bei leicht fahrlässiger Verletzung unwesentlicher Vertragspflichten haften wir nicht.
- Die Haftung aufgrund übernommener Garantien sowie aufgrund Produkthaftung bleibt unberührt, ebenso bei uns zurechenbaren Körper- oder Gesundheitsschäden oder bei Verlust des Lebens des Bestellers.
- Schadensersatzansprüche des Bestellers wegen eines Mangels verjähren nach einem Jahr ab Anlieferung der Ware. Dies gilt nicht, wenn uns Vorsatz oder grobes Verschulden vorwerfbar ist, sowie im Falle von uns zurechenbaren Körper- und Gesundheitsschäden oder bei Verlust des Lebens des Bestellers.

## IX. Rücknahme

Ordnungsgemäß bestellte und gelieferte Ware wird grundsätzlich nicht zurückgenommen. Ausnahmen bilden Rücknahmen, die mit uns vereinbart wurden. Zusätzlich müssen folgende Voraussetzungen erfüllt werden:

- Die Produkte müssen von uns oder von einem unserer Werkslager direkt bezogen worden sein.
- Einwandfreier und unveränderter Zustand der Ware.
- Rückgängigkeit ist die Rücknahme durch uns nur dann möglich, wenn die zur Rückgabe vorgesehenen Teile noch im Lieferprogramm sind.
- Rückversand muss „frei Haus“ an unser Werk Ergersheim oder an das zuständige Werkslager unter Angabe von Liefererscheindatum und -nummer erfolgen. Wertabschlag bei Rücknahme:
  - im 1. Jahr nach Liefertag *J. 10 %* vom Lieferpreis
  - im 2. Jahr nach Liefertag *J. 25 %* vom Lieferpreis
  - zwischen 3. und 5. Jahr nach Liefertag *J. 50 %* vom Lieferpreis
  - Ware älter als 5 Jahre keine Rücknahme möglich.

Nach Erhalt der Teile erfolgt die technische Überprüfung und Erstellung der Gutschrift unter Berücksichtigung eines etwaigen Wertabschlages. Frachtkosten, sofern sie für den ursprünglichen Versand für uns entstanden sind, vermindern den Restwert.

## X. Schutzrechte

- Bei kundenspezifischen Sonderanfertigungen haftet der Besteller uns für die Freiheit von Schutzrechten Dritter der in Auftrag gegebenen Lieferungen, stellt uns von etwaigen Ansprüchen Dritter frei und hat uns etwaigen aus einer Verletzung dieser Pflicht resultierenden Schaden zu ersetzen.
- Unsere Entwürfe und Konstruktionsvorschläge sind vertraulich zu behandeln und dürfen nicht an Dritte weitergegeben werden.
- Sämtliche Zeichnungen, Konstruktionspläne und Muster, die dem Besteller zugegangen sind, bleiben unser geistiges Eigentum.

## XI. Erfüllungsort, Gerichtsstand, sonstige Vereinbarungen

- Als Beschaffenheit der Ware gilt grundsätzlich nur unsere Produktbeschreibung als vereinbart. Öffentliche Äußerungen, Anpreisungen oder Werbung durch uns stellen daneben keine vertragsgemäße Beschaffenheitsangabe der Ware dar. Proben und Muster gelten als annähernde Anschauungsstücke für Qualität, Abmessungen und Farbe. Rechtsansprüche können hieraus nicht abgeleitet werden. Technische Änderungen sowie Änderungen in Form, Farbe und/oder Gewicht bleiben uns im Rahmen des Zumutbaren vorbehalten.
- Erhält der Besteller eine mangelhafte Montageanleitung, sind wir lediglich zur Lieferung einer mangelfreien Montageanleitung verpflichtet und dies auch nur dann, wenn der Mangel der Montageanleitung der ordnungsgemäßen Montage entgegensteht.
- Garantien im Rechtssinne erhält der Besteller durch uns nicht; Herstellergarantien bleiben hiervon unberührt.
- Erfüllungsort für unsere Lieferungen ist bei Lieferung ab Werk das Lieferwerk, bei Lieferung ab Lager das Lager. Erfüllungsort für alle Zahlungen ist Ergersheim / Bayern, Deutschland.
- Ausschließlicher Gerichtsstand für alle Streitigkeiten aus diesem Vertrag ist Fürth / Bayern, Deutschland. Dies gilt auch für evtl. Scheck- und Wechselklagen.
- Es gilt das Recht der Bundesrepublik Deutschland. Die Bestimmungen des UN-Kaufrechts finden keine Anwendung. Es ist allein der Text der deutschsprachigen Fassung dieser Allgemeinen Geschäftsbedingungen maßgeblich.
- Ergänzend gelten die mit den jeweiligen Preislisten bekannt gegebenen Sonderbedingungen unserer Produkte.
- Der Besteller ist selbst dafür verantwortlich, die Eignung von Waren für den beabsichtigten Verwendungszweck zu prüfen.
- Hinweis gemäß Bundesdatenschutzgesetz: Die zur Auftragsabwicklung erforderlichen Bestellerdaten werden gespeichert.

Stand 06/2017



# GENERAL TERMS AND CONDITIONS OF SALE AND DELIVERY

## I. General Provisions

1. The provisions of the contract between MEKRA Lang GmbH & Co. KG ("MEKRA Lang") and our orderers who are contractors as defined in para. 14 BGB are solely governed by these General Terms and Conditions. Our offers are exclusively meant for entrepreneurs as defined by Article 4 BGB (German Civil Code). Deviating business terms of the customer, even if they are known to us, shall not become a part of the contract. Our offers are always subject to change without notice. Our General Terms and Conditions of Sale and Delivery are considered accepted upon placement of order, at the latest upon receipt of goods. In the case of repeated business relations these General Terms and Conditions of Sale and Delivery also apply for all future transactions. Should individual provisions be or become completely or partially ineffective, then the validity of the other provisions shall thereby not be affected. MEKRA Lang and the customer shall agree upon a regulation the economic success of which shall be as close as possible to the ineffective one. Until such agreement the laws, administrative practice and judicature effective at the time of execution are to be applied.

## II. Conclusion of Contract and Prices

1. By ordering merchandise the customer bindingly declares that he wants to buy the merchandise ordered. He shall be bound to this statement for two weeks. We are entitled to accept the offer of a contract underlying the order within two weeks upon receipt of the latter by us. The acceptance may be declared in writing, electronically, or by delivery of the goods to the customer.

2. The obligations in electronic commerce according to Section 312e, par. 1 sentence 1, Nos. 1 to 3, and sentence 2 of BGB (German Civil Code) are excluded.

3. The conclusion of the contract takes place subject to the correct and timely delivery by our sub-suppliers to us. This applies only in case we are not responsible for the non-delivery, especially in case of the conclusion of a congruent hedging business transaction with our sub-suppliers. The customer shall be informed about the non-availability of the product without delay, and the equivalent, insofar as already paid, shall be reimbursed immediately.

4. All contractual financial obligations are to be fulfilled solely in EURO.

5. Prices are understood to be net as ex factory or supply depot. Freight, packaging and import costs, customs duties and other additional taxes are payable by the customer.

## III. Period of Delivery and Supply Commitment

1. Our written or electronic order confirmation shall be decisive for extent, type, and date of the delivery. Partial shipments shall be permitted.

2. A liability in meeting delivery deadlines determined as binding shall only be accepted under the condition of undisturbed flow of operations and distribution. In particular in cases of acts of God and other disruptive events at our facilities or those of our sub-suppliers or transport contractors, for example operational or traffic disruptions, fire, flooding, labour-, energy-, or traffic shortages, strikes, lockouts, official measures as well as technical or technological situations that considerably aggravate the execution of the contract, release us from liability in punctual delivery or give us the right to stop delivery without obligation for subsequent delivery.

3. If not agreed otherwise, we have the right to deliver earlier than the delivery deadline. Unless otherwise agreed upon, delivery effected by us one up to a maximum of two weeks after the stipulated delivery date shall not be considered as delayed.

4. Delivery deadlines shall be considered met when the goods have left the works or dispatch depot or the customer has received notice by expiration of the deadline of our readiness to deliver. Subsequent alteration of contract shall be cause for a reasonable extension of delivery deadlines.

5. In the case of contracts whose performance consists of several deliveries, non-performance, defective or delayed performance of one delivery remains without influence upon the other deliveries of the contract.

6. Default of payments, handing in of a state meant in lieu of an oath of disclosure in accordance with § 807 ZPO (German Code of Civil Procedure), temporary shortage of liquid funds, or public knowledge of a considerable deterioration of the financial circumstances of the customer shall entitle us at our discretion to demand payment in advance for outstanding deliveries or to stop deliveries immediately and to deny performance of current contracts. At the same time we shall be entitled to make immediately due and payable those accounts receivable from the customer which are not due yet.

## IV. Shipment, Passage of Risk

1. Unless otherwise agreed by the Parties, the choice of packaging, shipping routes and method of transportation is subject to our discretion.

2. The risk of accidental loss and accidental deterioration of the merchandise shall pass over to the customer upon handing it over, in case of a mail order purchase upon delivery of the matter to the forwarding agent, the carrier, or another person or institution determined to execute the shipment. If the customer is overdue in accepting, this shall be equal to a handing over of the merchandise.

3. Merchandise out of call orders shall be accepted within 3 months after issuance of the acknowledgement of order, unless otherwise agreed.

4. Insurance against breakage and transportation risks shall only be taken out upon special request and shall be billed.

5. Customs duties and other expenses, also the costs for payment of the necessary papers for import into the country of destination, shall be payable by the customer.

## V. Payments, Terms of Payment

1. Invoices shall be payable:

a) within 14 days from date of invoice with 2 % cash discount of the accumulated invoice value;

b) within 30 days from date of invoice without cash discount of the accumulated invoice value.

2. Cash discount shall only be granted after all payment commitments out of earlier deliveries have been fulfilled and the invoice amount has been punctually paid to us in cash or has been credited to our account by the aforementioned due dates. The drawing of a bill of exchange can thus

not lead to the granting of a cash discount. In case of cashless payment, especially when a cheque is submitted, the date of the credit entry shall be decisive. A cash discount cannot be granted in the case of payment or credit entry under reserve, with limiting conditions or any other restrictions. The customer shall assume all risks of method of payment. Invoices for tools are subject to immediate payment without cash discount.

3. Bills of exchange and checks shall only be accepted on account of payment. Corresponding credit entries are made only under the limiting condition of correct receipt of the complete amount due. We reserve the right to take in external or own acceptances. Costs and discount expenses are payable by the customer. We assume no responsibility for submission and protest. Protest imposed against the customer's own bills of exchange or non-immediate repayment of protested external bills of exchange shall entitle us to return all bills in circulation. At the same time we shall be entitled to make immediately due and payable those accounts receivable from the customer which are not yet due. Antedated checks shall not be accepted.

4. Interest on defaulted payment of 9%-points over the discount rate of the German Central Bank referred to in § 247 BGB (German Civil Law) as well as a liquidated damages of 40.00 Euro shall be charged in the case of missed payment dates. The right of assertion of further damages caused by delayed performance and other claims shall remain reserved.

5. Advance and part payments are not subject to interest payments.

6. The customer shall only be entitled to offset or withhold payment if his counterclaim is undisputed or has been determined legally binding. The customer may execute a right of retention only if his counter claim is based on the same contractual relationship.

7. Customer and invoice numbers are to be given by the customer when invoices are balanced. Delays or incorrect booking resulting from failure to do so shall be payable by the customer.

## VI. Retention of Ownership, Factoring

1. The delivered goods shall remain our property until payment of all claims has been received. The customer has the right to resell the proviso goods within the scope of proper and orderly course of business; however, a pledge or transfer by way of security is not permissible. The customer is required to ensure our rights in the case of resale of proviso goods on credit.

2. The accounts receivable by the customer based on the resale of the merchandise subject to reservation shall now already be transferred to us in the amount of the invoice. We hereby agree to accept this transfer. Regardless of the assignment, the customer shall retain the right to collect payment under the condition that he fulfils his responsibilities to us according to the underlying contractual relationship and does not fall into financial decline. Otherwise the customer must provide the information about the assignment necessary for collection upon our demand and notify his debtors of the respective assignment. In this case we reserve the right to collect the accounts receivable by ourselves.

3. A possible finishing or processing of the merchandise sold subject to reservation by the customer shall always take place on our behalf and by order of us, without any obligations resulting for us from this, however. In the case of processing of proviso goods with other goods not belonging to us, we are entitled to the co-owner portion of the resulting product corresponding to the value of the proviso goods in relation to the other processed goods. Insofar as here and in the following the value of the proviso goods is referred to, this value results from our invoice value.

4. Should the customer acquire sole ownership of the new product according to § 947 paragraph 2 BGB, it is agreed upon that the customer grants co-ownership in the proportion of the value of the processed, attached, or mixed proviso goods, and that he protects these free of charge.

5. In the case of resale of the proviso goods together with other goods, regardless of with or without processing, attachment or mixing, the assignment in advance agreed to above shall be valid only to the extent of the value of proviso goods that were resold together with the other goods. We shall be obligated to release on demand the securities entitled as provided above, if the value exceeds secured payments by 20 %.

6. The customer must immediately notify us and provide the material necessary for an intervention in the case of compulsory execution by third parties against the proviso goods or in case of claims assigned in advance. Any costs resulting from such intervention shall be payable by the customer.

7. The customer shall be obligated to adequately insure the merchandise sold subject to reservation against fire and burglary and has to prove such insurance to us on demand.

## VII. Warranty

1. The period of limitation for any warranty claim shall be 24 months as from handover of the goods.

2. First of all, we shall remedy a defect or make a substitute delivery at our discretion. In case of failure to rectify defects or to substitute delivery, the customer can demand rescission of the contract or reduction of the payment. In case there is only a minor contract violation, especially if there are only minor defects, the customer shall not have the right of contract cancellation, however.

3. The customer must notify us in writing of any obvious flaws immediately, at the latest within 7 days after receipt of the goods, and must refrain from any eventual working of protested goods. Otherwise claims based on defects are excluded. The timely dispatch shall suffice for the observance of the warranty deadline. The full burden of proof for all claim prerequisites rests with the customer, especially for the defect itself, for the date of the establishment of the defect, and for the timeliness of the complaint about the defect.

4. Defects which could not be ascertained within this time span despite careful inspection are to be reported to us in writing immediately upon discovery. If the customer opts for a withdrawal from the contract because of a legal imperfection or a physical defect after a failed subsequent fulfilment, then he shall not be additionally entitled to a claim for compensation because of the defect.

5. If, after a failed subsequent fulfilment, the customer opts for a compensation of the damage, then the merchandise shall remain with the customer if this can reasonably be considered acceptable. The compensation is restricted to the difference between the purchase price and the value of the defective

product. This shall not apply if we caused the contract violation maliciously.

6. Merchandise for which we have effected compensation shall become our property and is to be returned to us against reimbursement of costs.

7. Claims cannot be made for damages that resulted from the customer's culpably

a) improper handling or overstressing the purchased item or

b) altering the purchased item in a manner not agreed upon or

c) not following the instructions of the mounting or operating manual or

d) not observing the complaint and delivery responsibility according to points 3 and 4 above or

e) further using the purchased item after ascertaining the defect.

Natural wear and tear is excepted from the warranty.

## VIII. Liability

1. In case of simply negligent violations of obligations our liability shall be restricted to an average damage predictable for the type of merchandise, typical for such a contract, and immediate. This also applies in case of simply negligent violations of our legal representatives or agents. We shall not be held liable in case of a simply negligent violation of nonessential contractual obligations.

2. The liability by virtue of acceptance of a guarantee as well as due to product liability remains unaffected; the same applies in case of bodily harm or health impairment attributable to us or in the event of loss of life of the customer

3. Compensation claims of the customer because of a defect shall superannuate after one year from the delivery of the merchandise to the customer. This shall not apply if we can be charged with gross negligence as well as in case of bodily harm or health impairment attributable to us or in the event of loss of life of the customer.

## IX. Returns

Properly ordered and delivered goods shall in principle not be taken back. Returns that have been agreed upon with us shall remain the exception, which additionally require the following pre-requisites to be met:

1. The products must have been acquired directly from us or from one of our works depots.

2. Flawless and unaltered condition of the goods.

3. In principle, return shall only be possible when the articles in question are still in our product range.

4. Return shipment must be „free domicile“ to our Ergersheim works or to the appropriate works depot with accompanying delivery note date and number. Value reduction for returns:

- in the first year after delivery date *J.* 10 % of the contract price
- in the second year after delivery date *J.* 25 % of the contract price
- between the 3rd & the 5th year after deliv. date *J.* 50 % of the contract price
- merchandise over five years old - no return possible

Technical inspection and completion of the credit slip shall be carried out under consideration of eventual value reduction upon receipt of the articles. Freight costs, insofar as any occurred to us for the original shipping, reduce the remaining value.

## X. Industrial Property Rights

1. The customer is held liable to us for the exemption from industrial protection rights of third parties on articles ordered, indemnifies us against any possible claims of third parties and has to reimburse any damage to us possibly resulting from a violation of this obligation.

2. Our designs and design proposals are to be kept confidential and may not be passed on to third parties.

3. All drawings, construction plans, and samples which the customer has received, shall remain our intellectual property.

## XI. Place of Fulfillment and Jurisdiction, Other Agreements

1. On principle, the product description of the manufacturer is understood to be decisive for the characteristics of the goods. Public statements, sales talks, or advertisements made apart from this do not represent a contractual description of the characteristics of the goods. Samples and specimens serve as approximate illustrative articles in terms of quality, measurements and colour. Legal claims cannot be inferred from this. Technical changes as well as alterations in shape, colour, and/or weight are reserved within reasonable scope.

2. If the customer receives a faulty assembly instruction, we shall only be obligated to furnish a faultless assembly instruction, and this only if the fault of the assembly instruction is in contradiction with a proper assembly.

3. The customer does not receive warranties in the legal sense of the word from us; warranties of the manufacturers, however, shall remain unaffected by this.

4. Place of fulfillment for our deliveries ex works shall be the delivery works, for delivery ex storage the warehouse. Place of fulfillment for all payments shall be Ergersheim / Bavaria, Germany.

5. The exclusive place of jurisdiction for all litigations from this contract shall be Fuerth / Bavaria, Germany. This also applies to lawsuits based on a cheque or bill of exchange.

6. These provisions shall be governed by the Law of the Federal Republic of Germany. The provisions of the UN Purchase Law shall not be applicable. The wording of the German language version of our „General Terms and Conditions of Sale and Delivery“ shall solely be decisive for these General Business Terms.

7. The special terms of our products published with the appropriate price lists shall additionally be applicable.

8. The customer itself shall be responsible to examine the suitability of the goods for the intended final usage.

9. German law (BDSG-Federal Data Protection Law) requires us to inform you that all data of our customers are electronically saved.

As of: 06/2017



## Team Aftermarket

Günther Engel, Marco Wiesmann, Katharina Graf, Yannic Rauner, Sven Felbinger, Sven Gurrath,  
(Carina Ixtlahuac-Olsen, nicht im Bild)

# Standorte Aftermarkt

## Locations for the aftermarket



**MEKRALang GmbH & Co. KG**  
Buchheimer Str. 4  
91465 Ergersheim  
Germany  
Hotline +49 9847 989 8757  
Tel +49 9847 989-0  
bestellungen@mekra.de  
www.mekra.de



**MEKRA Lang International ČR. spol. s.r.o**  
Družstevní 185  
33008 Zruč  
Czech Republic  
Tel +42 0 377 824-893  
Fax +42 0 377 824-893  
mekra@mekra.cz  
www.mekra.cz



**MEKRA Lang do Brasil Ltda.**  
Avenida Paraná 2879  
Cajuru do Sul - Sorocoba  
SP 18105-000  
Brazil  
Tel +55 15 3235 3420  
Fax+55 15 3235 3421  
mekra@mekra.com.br  
www.mekra.com.br



**MEKRA FRANCE**  
Bâtiment G  
Avenue des Frères Lumière 26 - 32  
78190 Trappes  
France  
Tel +33 30 47 43 85  
Fax +33 30 47 45 16  
info@mekra.fr  
www.mekra.fr



**MEKRA Lang North America, LLC**  
101 Tillessen Boulevard  
Ridgeway, SC 29 130  
U.S.A.  
Tel +1 803 337 52 64  
Fax +1 803 337 52 65  
sales@lang-mekra.com  
http://www.lang-mekra.com



**MEKRA UK Limited**  
17 Willowbrook Road  
Ham Bridge Trading  
Estate BN14 8NA  
Worthing,  
Great Britain  
Tel +44 1903 206106  
Fax+44 1903 214395  
info@mekra.co.uk





**MEKRA Lang Otomotiv Yan Sanayi A.S.**  
Baskent Organize Sanayi Bölgesi  
19. Cad. No: 60  
Maliköy Sincan 06909  
Ankara  
Turkey  
Tel +90 312 640 12 16  
Fax +90 312 640 12 25  
mekratrurkey@mekra-turkey.com  
www.mekra-turkey.com

 **Komplettspiegel (Klasse II / IV)**  
complete mirror (class II / IV)  
rétroviseur complet (class II / IV)  
espeho completo (class II / IV)  
specchio completo (class II / IV)  
espejo completo (class II / IV)  
komplett spegel (class II / IV)  
kompletni zrcadlo (trída II / IV)  
зеркало в комплекте (класс II / IV)  
komple ayna (sinif II / IV)  
komplett tükör (II / IV tükörsztály)  
kompletne lustra (klasa II / IV)

 Schraube **parafuso** **skrv** **vida**  
screw **vite** **šroub** **csavar**  
vis **tornillo** **šrot** **šrubca**

 Kugelstange **kulstáng**  
ball joint **kulový držák**  
bras à rotule **šarvová opora**  
Junta de articulação **ayna destekleyicisi**  
staffa con snodo a sfera **golyóvégű rúd**  
barra con cabeza esférica **pręt z kulką**

 für 1- / 2- / 3- Spiegelbetrieb (Kabel, Schalter)  
pour 1- / 2- / 3- mirror operation (cable, switch)  
1 pour 1- / 2- / 3- commande(s) (câble, commutateur)  
 para 1 / 2 / 3 espelhos (cabo, interruptor)  
per 1 specchio / 2 specchi / 3 specchi (cavo, interruttore)  
servicio de 1- / 2- / 3- espejo(s) (cable, conmutador)  
1- / 2- / 3- spegelstyrning (kabel, styrspek)  
pro ovládání 1 zrcadla / 2 zrcadel / 3 zrcadel (kabel, ovladač)  
для управления 1 зеркалом / управления 2 / 3 зеркалами  
1- / 2- / 3- ayna kumandasi (kablo/salter)  
1- / 2- / 3- tükör működtetés (vezérlőkábel, állítókapcsoló)  
do obsługi 1, 2 lub 3 lusterek (kabele, przełącznik)

 Spiegelkopf ohne Glaseinheit (Klasse II / IV)  
mirror head without glassunit (class II / IV)  
boîtier, sans glace de rechange (class II / IV)  
cabeça de espelho sem unidade de vidro (class II / IV)  
carcassa senza vetro (class II / IV)  
carcasa, sin unidad de cristal (class II / IV)  
speghelvuud utan glas (class II / IV)  
hlava zrcadla bez skla (trída II / IV)  
Зеркала в сборе без зеркального элемента (класс II / IV)  
cansız ayna gövdesi (sinif II / IV)  
tükörfej tükör és hordozólap nélkül (II / IV tükörsztály)  
korpusz lustra bez wkładu (klasa II / IV)

 Spiegelhalter **supporto** **несущая опора**  
mirror holder **soporte** **ayna tutucusu**  
support **hállare** **tükörtartó**  
supporte de fixation **držák zrcadla** **uchwył**

 Stange **spiegelarm, komplett**  
bracket **držák zrcadla**  
bras de fixation **trubчатый кронштейн зеркала**  
braco de fixação **ayna kolu**  
braccio **tükörtartókar**  
soporte **wspornik / drążek**

 manuell verstellbar (Klasse II / IV)  
manually adjustable (class II / IV)  
reglage manuel (class II / IV)  
manual (class II / IV)  
regolazione manuale (class II / IV)  
manual (class II / IV)  
manuellt justerbar (class II / IV)  
manuálně ovládané (trída II / IV)  
переставляется вручную (класс II / IV)  
manuel olarak ayarlanabilen (sinif II / IV)  
kezi állítású (II / IV tükörsztály)  
regulowane ręcznie (klasa II / IV)

 Komplettsystem Klasse II + IV inkl. Spiegelstange  
complete system class II + IV incl. bracket  
système complet classe II + IV, bras de rétroviseur compris  
sistema completo classe II + IV, soporte incluso  
sistema completo classe II + IV completo di braccio  
sistema completo classe II + IV, braço incluído  
komplettsystem klass II + IV inkl. spegelstångar  
kompletní systém třídy II + IV včetně držáku zrcadla  
Системы класса II + IV включая кронштейн зеркала  
komple sistem sinif II + IV tutucu dahil  
komplett rendszer II és IV-es osztályú tükörökkel és karral  
kompletny system klasy II + IV + ramie lustra

 Scharnier **rótula** **knäed** **mafsal**  
hinge **cerniera** **záves** **csulópánt**  
charnière **rotula** **шарнир** **zawias**

 Haltebock **nedre hållare**  
lower holder **spodni držák**  
support de fixation **держатель**  
suporte inferior de fixação **tutucu**  
supporto inferiore **csukló**  
soporte bajo **uchwył**

 elektrisch verstellbar (Klasse II / IV)  
remote controlled (class II / IV)  
réglage électrique (class II / IV)  
életrico (class II / IV)  
regolazione elettrica (class II / IV)  
eléctrico (class II / IV)  
elektriskt justerbar (class II / IV)  
elektricky ovládané (trída II / IV)  
elektroupravľavateľne (class II / IV)  
uzaktan kumandalı (sinif II / IV)  
elektromosan állítható (II / IV tükörsztály)  
regulowane elektrycznie (klasa II / IV)

 Busspiegel mit Gelenkarm  
bus mirror with joint arm  
rétroviseur de car avec bras articulé  
espeho para ônibus com braço articulado  
specchio per autobus con braccio snodabile  
retrovisor para autocar con brazo articulable  
busspegel med ledad arm  
zrcadlo autobusu s kloubovým ramenem  
зеркало для автобуса  
otobüs aynası  
busztükör csuklós karral  
lustro autobusu na ramieniu przegubowym

 Adapter **adaptador** **adapter** **adaptör**  
adapter **adattatore** **adaptér** **adapter**  
adaptateur **adaptador** **переходник** **adapter**

 Aufsteckkeil **monteringskil**  
mounting wedge **nástrčný klin**  
semelle de fixation **установочный клин**  
cunha desmontável **bağlantı parçası**  
supporto a cuneo **ékes csatlakozó**  
cuña desmontable **klin do mocowania**

 Memory-Funktion (Speicherung der Spiegeleinstellung)  
memory function (storage of the position of the mirror)  
fonction de mémoire (pour réglage du rétroviseur)  
função Memória (memoriza a posição do espelho)  
funzione memoria (della posizione dello specchio)  
función de memoria (de la posición del espejo)  
minnesfunktion (lagring av inställningar)  
функция сохранения (мемори)  
hafıza fonksiyonu (ayna pozisyonu için)  
memória funkcióval (tükör beállításá mentve)  
funkcja pamięci (pamięć ustawienia)

 Busspiegel, hängend  
bus mirror, pendant mounting  
rétroviseur de car, montage suspendu  
espeho para ônibus com montagem em posição invertida  
specchio per autobus, montaggio appeso  
retrovisor para autocar, montaje en posición invertida  
busspegel, hängande  
zrcadlo autobusu visící  
зеркало для автобуса, свисающее  
otobüs aynası, asılır tip  
busztükör függő  
lustro autobusu wiszące

 Aufsteckkeil mit Direktkontakt  
mounting wedge with direct contact  
semelle de fixation avec contact direct  
cunha desmontável com elemento de contato direto  
supporto a cuneo con contatto diretto  
cuña desmontable con elemento de cont. directo  
monteringskil med direktkontakt  
nástrčný klin s priýmym kontaktom  
установочный клин с прямым электроконтактом  
direk temaslı bağlantı parçası  
ékes csatlakozó direkt kontaktussal  
klin do mocowania z bezpośrednim kontaktem

 manuell abklappbar  
manually retractable  
rabattable manuellement  
espeho retrátil manual  
ripiegabile manualmente  
abatable manualmente  
manuellt infällbar  
manuálně sklápny  
переставляется вручную, откидное  
manuel olarak katlanabilme  
kézzel behajtható  
ręcznie składane

 Busspiegel, stehend  
bus mirror, upright mounting  
rétroviseur de car, montage posé  
espeho para ônibus com montagem em pé  
specchio per autobus, montaggio verticale (ritto)  
retrovisor para autocar, montaje en posición de pie  
busspegel, stående  
zrcadlo autobusu stojící  
зеркало для автобуса, стоячее  
otobüs aynası, dik tip  
busztükör álló  
lustro autobusu stojące

 Faltenbalg **gummibalg**  
rubber boot **manžeta**  
soufflet de protection **резиновая гофра**  
carregador de borracha **körük**  
soffietto **gumiharmonika**  
guardapolvo **ostona / manczeta**

 Heizkabel, 2 polig (runder / ovaler Winkelstecker)  
heating cable, double pole (right angle connector, round / oval)  
câble chauffant, bipolaire (connexion fiche coudée ronde / ovale)  
cabo de aquecimento, bipolar (pino lateral, redondo / ovalado)  
cavo, bipolare (attacco 90°, rotondo / ovale)  
cable de calefacción, bipolar (clavija lateral, redondo / ovalado)  
kabel für uppvärmning, 2-polig (vinkelkontakt rund / oval)  
vyhřívací kabel, 2-pólový (kruhová / oválná úhlová zástrčka)  
кабель подкл. нагревателя, двухполюсной,  
(круглая угловая вилка / .....)  
ısıtıcı kablo, çift kutup (dik açılı konektör, yuvarlak / oval)  
2 polusna fűtőkábel ovális / kerek csatlakozóval  
przewód grzejny, 2 pin (okrągłe / owalne, wtyczka pod kątem)

 elektrisch abklappbar  
electrically retractable  
rabattable électriquement  
espeho retrátil eléctrico  
ripiegabile elettricamente  
abatable electricamente  
elektriskt infällbar  
elektricky sklápny  
переставляется электр., откидное  
motorlu olarak katlanabilme  
elektromosan behajtható  
elektrycznie składane

 Glaseinheit (Klasse II / IV)  
glass unit (class II / IV)  
glace sur support plastique (class II / IV)  
unidade de vidro (class II / IV)  
vetro con supporto in plastico (class II / IV)  
unidad de cristal (class II / IV)  
glas på platta (class II / IV) **sklo s deskou (trída II / IV)**  
зеркальный элемент с подножкой держателя (класс II / IV)  
ayna camı, plastik muhafazalı (sinif II / IV)  
tükör hordozólapjal (II / IV tükörsztály)  
wkład lustra (klasa II / IV)

 Steuerkabel **kabel för elstyrning**  
control cable **ovládaci kabel**  
câble de commande **кабель управления**  
cabo de controle **kontrol kablou**  
cavo di controllo **vezérlőkábel**  
cable de control **kabel strowania**

 Versorgungsleitung **elkabel**  
supply cable **zdrojový kabel**  
câble d'alimentation **провод питания**  
cabo de alimentación **besleme kablou**  
cavo di alimentazione **betápkábel**  
cable distribuidor **przewód zasilania**

 12 V **beheizt (12 / 24 Volt)**  
12 V **heated (12 / 24 Volt)**  
24 V **chauffant (12 / 24 Volt)**  
24 V **aquecido (12 / 24 Volt)**  
24 V **iscaldato (12 / 24 Volt)**  
24 V **calefactado (12 / 24 Volt)**  
24 V **med värme (12 / 24 Volt)**

 12 V **Spannung (12 / 24 Volt)**  
12 V **voltage (12 / 24 Volt)**  
24 V **voltage (12 / 24 Volt)**  
24 V **voltage (12 / 24 Volt)**  
24 V **tensione (12 / 24 Volt)**  
24 V **voltaje (12 / 24 Volt)**

 12 V **spänning (12 / 24 Volt)**  
12 V **napětí (12 / 24 Volt)**  
24 V **напряжение (12 / 24 вольт)**  
24 V **volt (12 / 24 Volt)**  
24 V  **feszültség (12 / 24 Volt)**  
24 V  **napięcie (12/24 V)**

 Ersatzglas **vetro di ricambio** **запасное стекло**  
spare glass **cristal de repuesto** **ayna camı**  
glace de rechange **reservglas** **csere tükörlep**  
vidro de reposição **náhradní sklo** **szkło wymienne**

 Heizfolie **värmeelement**  
heating foil **vyhřívací fólie**  
feuille chauffante **нагревательный элемент**  
manta aquecedora **ısıtıcı folyo**  
resistenza **fűtőfólia**  
lámina de calefacción **mata grzewcza**

 Spiegelverstellungsschalter **stýrspak**  
mirror switch **ovladač zrcadel**  
commutateur de rétroviseur **blauk управление**  
interruptor do espelho **ayna kumanda düğmesi**  
interruptore **tükörállító kapcsoló**  
commutador de espejo **przełącznik regulacji**

 12 W **Leistungsaufnahme (Watt)**  
12 W **power consumption (Watt)**  
12 W **puissance en watt**  
12 W **consumo de energia (Watt)**  
12 W **potenza (Watt)**  
12 W **consumo de energia (wattios)**

 15 W **strömförsörjning (Watt)**  
15 W **píkon (Watt)**  
15 W **потребляемая мощн. (ватт)**  
15 W **güç tüketimi (Watt)**  
15 W **teljesítmény (watt)**  
15 W **pobór mocy (wat)**

 Abdeckung (Klasse II / IV)  
back cover (class II / IV)  
cache (class II / IV)  
cobertura traseira (class II / IV)  
calotta (class II / IV)  
pared dorsal (class II / IV)

 **bakstycke (class II / IV)**  
**zadní kryt (trída II / IV)**  
задняя крышка корпуса (класс II / IV)  
**arka kapak (sinif II / IV)**  
**burkolat (II / IV tükörsztály)**  
pokrywa lustra (klasa II / IV)

 kompletter Kabelsatz für elektrisch verstellbare Spiegel  
complete cable set for remote controlled mirrors  
kit complet pour réglage électrique  
kit completo de cabos para espelhos elétricos  
set di cavi per specchi elettrici  
juego completo de cables para espejos eléctricos  
kabelsats för eljusterbara speglar  
kompletní kabelová sada pro elektricky ovládaná zrcadla  
полный комплект кабелей с блоком управления для электроуправляемых зеркал  
uzaktan kumandalı aynalar için kablo seti  
komplett kabelkötég elektromosan állítható tükörkhöz  
komplet kabló do lustra sterowanego elektrycznie

 Wölbungsradius des Spiegelglases  
radius of shading of the mirror glass ("plan" = flat)  
rayon de convexité du verre ("plan" = plat)  
Raio de convexidade do vidro ("plan" = plano)  
raggio di curvatura dello specchio ("plan" = piano)  
radio de convexidad del cristal ("plan" = plano)  
bőjningsradius på spegelglas („plan" = plöskig)  
rádius krzywizny szkła zrcadla ("plan" = płoché)  
bükiüm yançarı ("plan" = düz)  
tükör hajlítási sugara („plan" = sík tükör)  
promień krzywizny szkła lustra („plan" = płaski)

 Rahmen **aro** **ram** **çerçeve**  
frame **cornice** **rám** **keret**  
cadre **marco** **rama**

 Getriebe **motor** **motor** **motor**  
actuator **attuateur** **motorek** **hajtómű**  
moteur **motor** **электродпривод** **tryby sterujące**

 Blinker (-Gehäuse)  
indicator (housing)  
clignotant **körriktningsvisare**  
luz de seta (com capa) **blinker**  
freccia (lampeggiatore) **указатель поворота**  
intermittente **sinyal lamba yuvası**  
**index (ház)**  
**obudowa kierunkowskazu**

 asphärisch **asferico** **асферическое**  
aspherical **esférico** **асферич**  
non-sphérique **asfärisk** **асферичне**  
esférico **asférică**

 Farbe schwarz / grau / chrom  
colour black / grey / chrome  
couleur noire / grise / chrome  
cor preto / cinza / cromado  
coloro nero / grigio / cromo  
color negro / gris / cromo  
färg svart / grå / krom  
barva černá / šedivá / chromová  
цвет: чёрный / серый / хром  
renk siyah / gri / krom  
fekete / szürke / króm színben  
kolor: czarny / szary / chromowy

 Haltelasche (mit / ohne Schraube)  
clamping device (with / without screw)  
collier de fixation (avec / sans vis)  
abracadeira (com / sem parafuso)  
dispositivo di bloccaggio (con / senza vite)  
abrazadera (con / sin tornillo)  
klammer (med / utan skruv)  
svorka (s / bez šroubu)  
серга-держатель / зажимной элемент (с / без винта)  
kelepek (vidali / vidasz)  
bilincs (csavarral / csavar nélkül)  
objema (z / bez šrubu)

 Reduzierhülse **hylsa**  
reducing sleeve **redukční pouzdro**  
manchon de réduction **ограничивающая втулка**  
reductor **düştürücü rakor**  
riduttore **csökkentőhüvely**  
la reducción de manga **tuska redukująca**

Anbau • mounting • assemblage • montagem • montaggio • montaje  
montering • montáž • монтаж • montaj • gyűllekezés • montaj

Verwendung • application • aplicação • applicazione • aplicación  
osňokan • použití • применение • Kullanimi • alkalmazás • aplicacja

links / rechts einsetzbar  
applicable for left / right hand side  
applicable à gauche / à droite  
aplicável para esquerda / direita  
per applicazione sinistro / destro  
aplicable para izquierda / derecha  
justerbar vänster / höger  
použiteľné pro levou / pravou / levou/pravou stranu  
для применения слева / справа  
sol ve sağ tarafa kullanilabilen / sol/sağ tarafa kullanilabilen  
bal / jobb oldalra felszerelhető  
montáž: strana lewa / prawa

Anbau oben / unten  
mounting top / bottom  
montage haut / bas  
montagem superior / inferior  
montaggio superiore / inferiore  
montaje superior / inferior  
Montering upp / ned  
montáž nahoru / dolů  
монтаж сверху / снизу  
montaj üst / alt  
felül / alul szerelt  
montáž góra / dót

für links / rechts gesteuerte Fahrzeuge  
for left / right hand driven vehicles  
pour véhicules conduites à gauche / à droite  
para veículos conduzidos pela esquerda / direita  
per veicoli con guida sinistra / destra  
para vehiculos conducidos a la izquierda / a la derecha  
föer vänster / högerstyrda fordon  
pro levo / pravostroanné řízená vozidla  
для автомобилей с рулём слева / справа  
sol ve sağdan direksiyonlu araçlar için  
soldan / sağdan direksiyonlu araçlar için  
bal / jobb oldalt vezetett járművekhez  
dla ruchu lewo / prawo stronnego

links einsetzbar für rechts gesteuerte Fahrzeuge  
applicable left hand side for right hand drive vehicles  
applicable à gauche pour véhicules conduites à droite  
aplicável para esquerda / veículos conduzidos pela direita  
per applicazione sinistro per veicoli con guida destra  
aplicable para izquierda / vehiculos conducidos a la derecha  
justerbar vänster för högerstyrda fordon  
použiteľné pro pravou stranu pro levostranné řízená vozidla  
для применения справа, в автомобиле с рулём слева  
sağdan direksiyonlu araçlar için sol tarafa kullanilabilen  
bal oldalra felszerelhető, jobb oldalon vezetett járművekhez  
strona lewa dla ruchu prawostroznego

rechts einsetzbar für links gesteuerte Fahrzeuge  
applicable right hand side for left hand drive vehicles  
applicable à droite pour véhicules conduites à gauche  
aplicável para direita / veículos conduzidos pela esquerda  
per applicazione destro per veicoli con guida sinistra  
aplicable para derecha / vehiculos conducidos a la izquierda  
justerbar höger för vänsterstyrda fordon  
použiteľné pro pravou stranu pro levostranné řízená vozidla  
для применения справа, в автомобиле с рулём слева  
soldan direksiyonlu araçlar için sağ tarafa kullanilabilen  
jobb oldalra felszerelhető, bal oldalon vezetett járművekhez  
strona lewa dla ruchu lewostronnego

links einsetzbar für links gesteuerte Fahrzeuge  
applicable left hand side for left hand drive vehicles  
applicable à gauche pour véhicules conduites à gauche  
aplicável para esquerda / veículos conduzidos pela esquerda  
per applicazione sinistro per veicoli con guida sinistra  
aplicable para izquierda / vehiculos conductos a la izquierda  
justerbar vänster för vänsterstyrda fordon  
použiteľné pro levou stranu pro levostranné řízená vozidla  
для применения слева, в автомобиле с рулём слева  
soldan direksiyonlu araçlar için sol tarafa kullanilabilen  
jobb oldalra felszerelhető, bal oldalon vezetett járművekhez  
strona lewa dla ruchu lewostronnego

rechts einsetzbar für rechts gesteuerte Fahrzeuge  
applicable right hand side for right hand drive vehicles  
applicable à droite pour véhicules conduites à droite  
aplicável para direita / veículos conduzidos pela direita  
per applicazione destro per veicoli con guida destra  
aplicable para derecha / vehiculos conductos a la derecha  
justerbar höger för högerstyrda fordon  
použiteľné pro pravou stranu pro pravostroanné řízená vozidla  
для применения справа, в автомобиле с рулём справа  
sağdan direksiyonlu araçlar için sağ tarafa kullanilabilen  
jobb oldalra felszerelhető, jobb oldalon vezetett járművekhez  
strona lewa dla ruchu lewostronnego

Fahrzeugbreite  
width of vehicle  
largeur de véhicule  
largura do veículo  
larghezza del veicolo  
anchura del vehículo  
fordonsbredd  
šířka vozidla  
ширина автомобиля  
araç genişliği  
járműlélességig  
szerozokó pojazdu

Anbau am Türrahmen  
mounting on the door frame  
montage cadre portière  
montado na porta  
montaggio su cornice porta  
montaje en el marco de la puerta  
montering på dörrkarm  
montáž na rám dveří  
монтаж на раму двери  
araç kapaı çerçevesine montaj  
ajtkeretre szerelhető  
montaż na drzwiach

integrierter Halter  
integrated holder  
support intégré  
suporte de fixação integrado  
supporto integrato  
soporte integrado  
integrerad hållare  
integrovaná montáž  
интегрированный  
tűmlesztés ayna tutucusu  
integrált tartó  
zintegrowany uchwył

Winkelstellung  
angularity  
angle of fixation  
ángulo  
angolatura  
angularidad  
vinkel  
úhel nastaveni  
açı pozisyonu  
szögállás  
położenie  
kątowe

Material • matériel • materiale • material  
материал • materiyal • anyag • materiał

ABS Spiegelgehäuse: Kunststoff ABS (schwarz / grau)  
mirror housing: plastic ABS (black / grey)  
bořtier: matière plastique ABS (noir / argenté)  
carcaça: plástico ABS (preto / cinza)  
carcassa: plastica ABS (nero / grigio)  
carcasa: plástico ABE (negro / gris)  
spegeľhus: plast ABS (svart / grå)  
skořepina zrcadla: umělá hmota ABS (černá / šedivá)  
корпус зеркала: пластмасса ABS (цвет чёрный / серый)  
ayna gövdesi plastik ABS (siyah / gri)  
tűkőrház ABS-ből (fekete / szürke)  
obudowa lustra: tworzywo ABS (kolor czarny / szary)

ASA Spiegelgehäuse: Kunststoff ASA, schwarz  
mirror housing: plastic ASA, black  
bořtier: matière plastique ASA, noir  
carcaça: plástico ASA, preto  
carcassa: plastica ASA, nero  
carcasa: plástico ASA, negro  
spegeľhus: plast ASA, svart  
skořepina zrcadla: umělá hmota ASA, černá  
корпус зеркала: пластмасса АСА, цвет чёрный  
ayna gövdesi plastik ASA, siyah  
tűkőrház ASA-ből, fekete  
obudowa lustra: tworzywo ASA, kolor czarny

PP Spiegelgehäuse: Kunststoff PP (Polypropylen), schwarz  
mirror housing: plastic PP (polypropylene), black  
bořtier: matière plastique PP (polypropylène), noir  
carcaça: plástico PP (polipropileno), preto  
carcassa: plastica PP (polipropilene), nero  
carcasa: plástico PP (polipropileno), negro  
spegeľhus: plast PP (polypropylen), svart  
skořepina zrcadla: umělá hmota PP (Polypropylen), černá  
корпус зеркала: пластмасса Полипропилен, цвет чёрный  
ayna gövdesi plastik PP (Polipropilen), siyah  
tűkőrház PP-ből, fekete  
obudowa lustra: tworzywo PP (polipropylen), kolor czarny

PC Spiegelgehäuse: Kunststoff PC (Polycarbonat) schwarz  
mirror housing: plastic PC (Polycarbonat) black  
bořtier: matière plastique PC (Polycarbonat) noir  
Carcaça: plástico PC (Polycarbonato) preto  
carcassa: plastica PC (Polycarbonato) nero  
carcasa: plástico PC (Polycarbonato) negro  
spegeľhus: plast PC (Polycarbonat) svart  
skořepina zrcadla: umělá hmota PC (Polycarbonat) černá  
корпус зеркала: пластмасса Поликарбонат, цвет чёрный  
ayna gövdesi plastik polycarbonat siyah  
tűkőrház PC-ből, fekete  
obudowa lustra: tworzywo PC (poliwęglan), kolor czarny

PU Spiegelstange umschäumt mit PU (Polyurethan)  
mirror bracket foamed with PU (polyurethan)  
le bras du rétroviseur est recouvert de polyuréthane  
Braço revestido de espuma sintética PU (Poliuretano)  
braccio schiumato con PU (polyuretan)  
brazo revestido de espuma sintética PU (Polyuretano)  
speqelarm i skumformad PUR (polyuretan)  
trubka držáku zpětného zrcadla zalisovaná v Polyurethanu  
брус зеркала покрытый ПУ (полиуретаном)  
ayna kolu polyüretan kaplı  
tűkőrtartó kar habosított PU-val borítva  
ramię lustra wyściętane PU (poliuretana)

verzinktes Stahlblech  
galvanized sheet steel  
bořtier en tôle zinguée  
chapa de aço galvanizada  
acciaio zincato  
carcasa de chapa de acero galvanizada  
galvaniserad plát  
pozinkovaný plech  
оцинкованная листовая сталь  
galvanizált metal plaka  
horganyzott acéllemez  
blacha ocynkowana

Stahlrohr  
steel tube  
tube en acier  
tubo de aço  
tubo in acciaio  
tubo de acero  
stálrör  
ocelová trubka  
стальная трубка  
çelik boru  
acélcső  
rura stalowa

Alu Alu  
aluminium tube  
tube en aluminium  
tubo de aluminio  
tubo de alluminio  
tubo de aluminio  
aluminiumrör  
hliníková trubka  
alüminyum boru  
alucső  
rura aluminiowa

Zeitraum • space of time • espace de temps • período de tempo  
periodo di tempo • espacio de tiempo • period • období  
период времени • dőnem • időbeni kiterjesztés • okres czasu

verwendbar ab Baujahr ... des Fahrzeugs (Monat / Jahr)  
usable from year of production ... of the vehicle (month / year)  
utilisable à partir de l'année ... du véhicule (mois / an)  
aplicado a partir da data de produção do veículo (mês / ano)  
utilizzabile dall'anno di produzione del veicolo (mese / anno)  
utilizable desde el año de fabricación del vehículo (mes / año)  
användbar för fordon med produktionsår from (månad / år)  
použiteľné od roku výroby vozidla (mesíc / rok)  
применять до ... года изготовления (год / месяц)  
Aracın üretim yılından sonra kullanilabilir (ay / yıl)  
alkalmazható ... évjáratig (év / hónap)  
rok budowy pojazdu od ... (miesiąc / rok)

verwendbar bis Baujahr ... des Fahrzeugs (Monat / Jahr)  
usable until year of production ... of the vehicle (month / year)  
utilisable jusqu'à l'année ... du véhicule (mois / an)  
aplicado até a data de produção do veículo (mês / ano)  
utilizzabile fino all'anno di produzione del veicolo (mese / anno)  
utilizable hasta el año de fabricación del vehículo (mes / año)  
användbar för fordon med produktionsår to (månad / år)  
použiteľné do roku výroby vozidla (mesíc / rok)  
применять до ... года изготовления (год / месяц)  
Aracın üretim yılına kadar kullanilabilir (ay / yıl)  
alkalmazható ... évjáratig (év / hónap)  
rok budowy pojazdu do ... (miesiąc / rok)

Zeitraum  
space of time  
espace de temps  
período de tempo  
periodo di tempo  
espacio de tiempo  
period  
obdobi  
период времени  
dőnem  
időbeni kiterjesztés  
okres czasu

Spiegelklassen • mirror classes • classes de rétroviseurs • classes de espelhos  
classi di specchio • classes de retrovisores • speqelklasser • řřidy zrcadel  
klassy zerkal • ayna siniflari • tükörosztályok • klasy luster

I Spiegelklasse I (Innenspiegel)  
mirror class I (interior mirror)  
rétroviseur classe I (miroir intérieur)  
espelho classe I (espelho interior)  
specchio classe I (specchio interno)  
espejo clase I (espejo interior)  
speqelklass I (innerspeqel)  
zrcadlo řřidy I (zrcadlo vnřřitní)  
зеркало класс I (внутреннее зеркало)  
sinif I ayna (iç ayna)  
I tükörosztály (belső tükör)  
lustra klasy I (wsteczne)

II Spiegelklasse II / III (Hauptspiegel)  
mirror class II / III (main mirror)  
rétroviseur classe II / III (rétroviseur principal)  
espelho classe II / III (espelho principal)  
specchio classe II / III (retrovissore principale)  
espejo clase II / III (espejo principal)  
speqelklass II / III (huvudspeqel)  
zrcadlo řřidy II / III (zrcadlo hlavní)  
зеркало класс II / III (главное зеркало)  
sinif II / III ayna (ana ayna)  
II / III tükörosztály (főtükör)  
lustra klasy II / III (główna)

IV Spiegelklasse IV (Weitwinkelspiegel)  
mirror class IV (wide angle mirror)  
rétroviseur classe IV (rétroviseur grand angle)  
espelho classe IV (espelho auxiliar)  
specchio classe IV (coppa grandangolo)  
espejo clase IV (espejo de gran ángulo)  
speqelklass IV (vidvinkelspeqel)  
zrcadlo řřidy IV (zrcadlo širokouhľé)  
зеркало класс IV (широкоугольное зеркало)  
sinif IV ayna (geniş görüş aynası)  
IV tükörosztály (nagy látószögű tükör)  
lustra klasy IV (szerokokątne)

V Spiegelklasse V (Rampenspiegel)  
mirror class V (roof mirror)  
rétroviseur classe V (miroir d'accostage)  
espelho classe V (espelho de rampa)  
specchio classe V (specchio guardaruota)  
espejo clase V (espejo de rampa)  
speqelklass V (närskiktspeqel)  
zrcadlo řřidy V (zrcadlo rampové)  
зеркало класс V (зеркало для рамы)  
sinif V ayna (kapaı üstü aynası)  
V tükörosztály (rampatükör)  
lustra klasy V (rampowe)

VI Spiegelklasse VI (Frontspiegel)  
mirror class VI (front-under mirror)  
rétroviseur classe VI (miroir frontal)  
espelho classe VI (espelho frontal)  
specchio classe VI (guardaruota anteriore)  
espejo clase VI (retrovisor para parte frontal del vehículo)  
speqelklass VI (frontspeqel)  
zrcadlo řřidy VI (zrcadlo čelní)  
зеркало класс VI (фронтальное зеркало)  
sinif VI ayna (ön tapın aynası)  
VI tükörosztály (fronttükör)  
lustra klasy VI (przednie)

II + IV Spiegelsystem Klasse II + IV  
(Hauptspiegel + Weitwinkelspiegel)  
mirror system class II + IV  
(main mirror + wide angle mirror)  
système de rétroviseurs classe II + IV  
(rétroviseur principal + rétroviseur grand angle)  
espelho classe II + IV  
(espelho principal + espelho auxiliar)  
sistema di specchi classe II + IV  
(retrovissore principale + coppa grandangolo)  
sistema de retrovisores classe II + IV  
(espejo principal + espejo de gran ángulo)  
speqelssystem klass II + IV  
(huvudspeqel + vidvinkelspeqel)  
systém zpětných zrcadel řřidy II + IV  
(zrcadlo hlavní + zrcadlo širokouhľé)  
Система зеркал класс II + IV  
(главное + широкоугольное зеркало)  
sinif II + IV ayna sistemi  
(ana ayna + geniş görüş aynası)  
tükörrendszert II és IV osztályok tükörökkel  
(fő és nagy látószögű tükörökkel)  
system lusterek klasy II + IV  
(główna + szerokokątne)

II + V Spiegelsystem Klasse II + V  
(Hauptspiegel + Rampenspiegel)  
mirror system class II + V  
(main mirror + roof mirror)  
système de rétroviseurs classe II + V  
(rétroviseur principal + miroir d'accostage)  
espelho classe II + V  
(espelho principal + espelho de rampa)  
sistema di specchi classe II + V  
(retrovissore principale + specchio guardaruota)  
sistema de retrovisores classe II + V  
(espejo principal + espejo de rampa)  
speqelssystem klass II + V  
(huvudspeqel + närskiktspeqel)  
systém zpětných zrcadel řřidy II + V  
(zrcadlo hlavní + zrcadlo rampové)  
Система зеркал класс II + V  
(главное + зеркало для рамы)  
sinif II + V ayna sistemi  
(ana ayna + kapaı üstü aynası)  
tükörrendszert II és V osztályok tükörökkel  
(fő és rampa tükörökkel)  
system lusterek klasy II + V  
(główna + rampowe)

EGE EG- / ECE - gerecht  
according to EEC-norm  
conforme aux normes / CE  
conforme normas da CE  
a norma CEE  
conforme a las normas CE  
EG-godkänd  
splňuje normy EU  
соответствует нормам ECE  
EEC normlarına uygundur  
EG / ECE -nek megfelelően  
zgodne z EC / ECE

Katalogseite  
catalogue page  
page du catalogue  
página do catálogo  
oldal a katalógusban  
página catálogo  
Katalogsida  
strana katalogu  
strаница каталога  
katalóg sayfasi  
oldal a katalógusban  
strona w katalogu

# MEKRA Lang - passion for excellence.

Contents are subject to change  
Last Update: March 2022  
[www.mekra.de](http://www.mekra.de)

